



SCULE PNEUMATICE



Maner ergonomic

Sculele pneumatice Unior au un maner ergonomic pentru o manipulare usoara, in timp ce carcasa lor robusta garanteaza o durata lunga de viata chiar si in cele mai dificile conditii de lucru. Calitatea superioara a materialelor si realizarea de mare precizie a mecanismului de antrenare garanteaza functionarea perfecta la moment de torsiune mare, in timp ce capetele de antrenare sunt tratate termic pentru a rezista la momente de torsiune mari si utilizare de lunga durata.



Executare eficienta

Datorita aerului comprimat, uneltele pneumatice Unior permit executarea de actiuni variate repede, eficient, simplu si in conditii de siguranta



Scule pneumatice 3/8"	273
Scule pneumatice 1/2"	273
Scule pneumatice 3/4"	274
Scule pneumatice 1"	276
Scule pneumatice 1.1/2"	276
Ciocan pneumatic	276
Slefuitoare, polizoare, masini de polisat si de gaurit pneumatice	277
Accesorii pneumatice	279
Dalti SDS plus si SDS max	281



Cele mai inalte standarde de siguranta

sculele pneumatice Unior se disting prin inalta lor calitate si functionarea in conditii de siguranta indeplinind cele mai inalte standarde de siguranta. Utilizarea lor simpla face sculele potrivite pentru uz domestic precum si pentru utilizatori profesionisti, care pot alege dintrogama variata de antrenoare pneumatice, ciocane pneumatice si seturi ce contin accesorii diferite.

Cum se conecteaza sculele pneumatice Unior ?



presiune maxima aer: 9,5 Bar

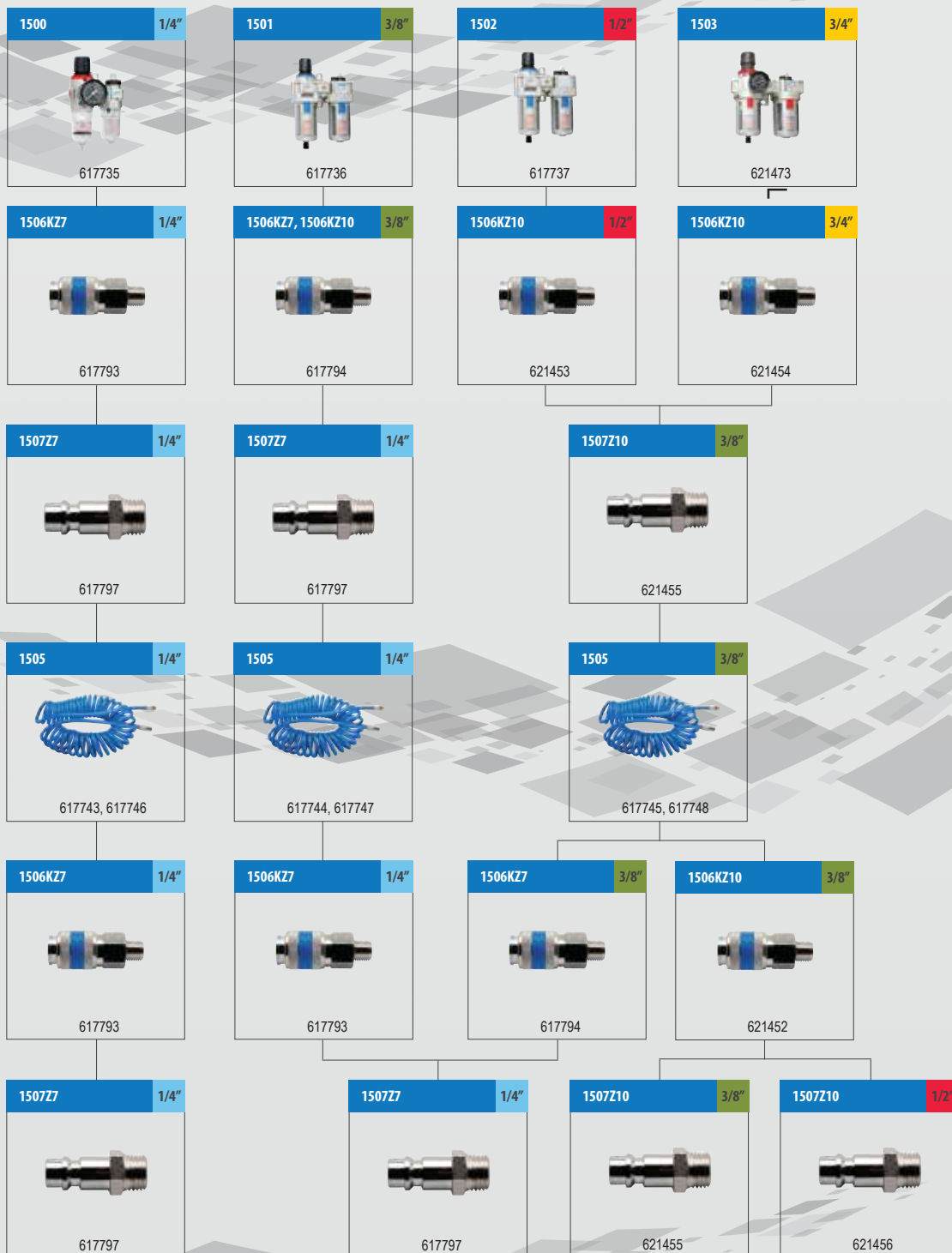

Cum realizati conectarea corecta a uneltei?

Model	Part Number	Size	Length
1506KN7	617795	1/4"	20
1506KN7	617796	3/8"	20
1506KZ7	617793	1/4"	20
1506KZ7	617794	3/8"	20
1506KZ10	621452	3/8"	24
1506KZ10	621453	1/2"	24
1506KZ10	621454	3/4"	27
1507Z7	617797	1/4"	14
1507Z7	617798	3/8"	19
1507Z7	618483	1/2"	22
1507Z10	621455	3/8"	17
1507Z10	621456	1/2"	24
1507Z10	621457	3/4"	27

- 1508A (617767)
- 1508B (617768)
- 1514 (615320)
- 1531 (615318)
- 1522 (627565)

- 1517 P (617728)
- 1517 S (617729)
- 1541 (615320)
- 1561 (615322)
- 1551 (615319)
- 1562 (615321)
- 1571 (615324)
- 1510 (617733, 617713)
- 1514 (617714, 617715)
- 1532 (627566)
- 1552 (627567)
- 1563 (627568)
- 1515 (617726)
- 1515 H (617727)
- 1516 (617731)
- 1516 A (617732)
- 1531 (615318)
- 1518 (617730)
- 1564 (627569)
- 1566 (627570)
- 1572 (615323)
- 1573 (627571)
- 1591 (615325)
- 1592 (615326)
- 1596 (617690)
- 1597 (617691)



Avertizare!

- Cititi instructiunile inainte de a utiliza unelta!
- Purtati intotdeauna echipament de protectie!

1522

Antrenor reversibil pneumatic 1/4"

- rulment cu ace
- cap clichet robust
- rulment cu bile
- maner antialunecare
- regulator de aer model nou
- racord aer pivotant la 360°
- evacuare din spate

Caracteristici tehnice:

- turatie mers in gol: 200 rpm
- patrat de antrenare: 1/4"
- cuplu maxim: 41 Nm
- racord aer: 1/4"
- diametru recomandat furtun aer: 3/8"
- consum de aer: 113 l/min
- lungime: 196 mm
- greutate: 0,5 kg
- nivel de vibratii: 1,8 m/s²
- nivel de zgomot: 79 dB(A)
- presiune aer recomandata: 6,2 bar

Utilizare

- industria auto, industria aerospaciala, echipament agricol, industria grea, constructia de masini, industria de constructii navale, montari individuale

Important

- este recomandata folosirea capetelor de impact UNIOR



UNIOR

627565	1/4"	196	41	520	IF	1	893.28
--------	------	-----	----	-----	----	---	--------

1531

Antrenor reversibil pneumatic 3/8"

- viteza de rotatie 250 rot/min
- moment de torsiune max. 54 Nm
- presiunea maxima de aer comprimat: 6, 2 Bar
- consum de aer comprimat 62 l/min
- racord de aer 1/4"
- capacitate maxima de strangere M 6

Avantaje:

- scula mica si compacta
- calitatea productiei
- maner rotitor
- reglare rapida si usoara a sensului de rotatie
- supapa de protectie previne intrarea necontrolata a aerului in scula

Utilizare

- industria auto
- industria aerospaciala
- echipament agricol
- industria grea
- constructia de masini
- industria de constructii navale
- montari individuale

Important

- este recomandata folosirea capetelor de impact UNIOR

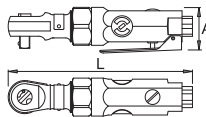

UNIOR

615318	3/8"	37	165	54	520	IF	1	761.15
--------	------	----	-----	----	-----	----	---	--------

1532

Antrenor reversibil pneumatic 3/8"

- rulment cu ace
- cap clichet robust
- rulment cu bile
- maner antialunecare
- regulator de aer model nou
- racord aer pivotant la 360°
- evacuare din spate

Caracteristici tehnice:

- turatie mers in gol: 200 rpm
- patrat de antrenare: 3/8"
- cuplu maxim: 54 Nm
- racord aer: 1/4"
- diametru recomandat furtun aer: 3/8"
- consum de aer: 113 l/min
- lungime: 196 mm
- greutate: 0,5 kg
- nivel de vibratii: 1,8 m/s²
- nivel de zgomot: 79 dB
- presiune aer recomandata: 6,2 bar

Utilizare

- industria auto, industria aerospaciala, echipament agricol, industria grea, constructia de masini, industria de constructii navale, montari individuale

Important

- este recomandata folosirea capetelor de impact UNIOR



UNIOR

627566	3/8"	196	54	500	IF	1	912.95
--------	------	-----	----	-----	----	---	--------

55839

NOU

Clichet pneumatic 1/4" 30 Nm 300 rpm

- industria auto, industria aerospaciala, echipament agricol, industria grea, constructia de masini, industria de constructii navale, montari individuale
- reversibil
- evacuarea aerului reglabila
- dimensiuni mici pentru locuri inaccesibile

Pre Comanda

EGA Master
ART IN INNOVATION

55839	Cuplul de strangere	500	1531.91
	30 Nm / 22 ft-lb		
	Cuplu maxim de strangere	30 Nm / 22 ft-lb	
	Cuplu recomandat	30 Nm / 22 ft-lb	
	Cuplu maxim de slabire	30 Nm / 22 ft-lb	
	Pozitie imConsumul de aer	110 l/min	
	Admisie	1/4"	
	Nivelul de presiune a zgomotului	85,5 dBA	
	Nivel de putere de zgomot	96,5 dBA	
	Vibratii	7,3 m/s ²	
	Presiune de lucru	6,3 bari / 90 PSI	

55840

NOU

Clichet pneumatic 3/8" 68 Nm 175 rpm

- industria auto, industria aerospaciala, echipament agricol, industria grea, constructia de masini, industria de constructii navale, montari individuale
- reversibil
- evacuarea aerului reglabila
- maner din poliuretan

Pre Comanda

EGA Master
ART IN INNOVATION

55840	Cuplul de strangere	500	1531.91
	30 Nm / 22 ft-lb		
	Cuplu maxim de strangere	68 Nm / 50 ft-lb	
	Cuplu recomandat	68 Nm / 50 ft-lb	
	Cuplu maxim de slabire	68 Nm / 50 ft-lb	
	Pozitie imConsumul de aer	80 l/min	
	Admisie	1/4"	
	Nivelul de presiune a zgomotului	82,8 dBA	
	Nivel de putere de zgomot	93,8 dBA	
	Vibratii	2,6 m/s ²	
	Presiune de lucru	6,3 bari / 90 PSI	

55841

NOU

Clichet pneumatic 1/2" 68 Nm 175 rpm

- industria auto, industria aerospaciala, echipament agricol, industria grea, constructia de masini, industria de constructii navale, montari individuale
- reversibil
- evacuarea aerului reglabila
- maner din poliuretan

Pre Comanda

EGA Master
ART IN INNOVATION

55841	Cuplul de strangere	500	1914.70
	30 Nm / 22 ft-lb		
	Cuplu maxim de strangere	68 Nm / 50 ft-lb	
	Cuplu recomandat	68 Nm / 50 ft-lb	
	Cuplu maxim de slabire	68 Nm / 50 ft-lb	
	Pozitie imConsumul de aer	80 l/min	
	Admisie	1/4"	
	Nivelul de presiune a zgomotului	82,8 dBA	
	Nivel de putere de zgomot	93,8 dBA	
	Vibratii	2,8 m/s ²	
	Presiune de lucru	6,3 bari / 90 PSI	

1541

Pistol pneumatic 3/8"

- viteza de rotatie 10000 rot/min
- moment de torsiune max. 271 Nm
- presiunea maxima de aer comprimat: 6, 2 Bar
- consum de aer comprimat 70 l/min
- record de aer 1/4"
- capacitate maxima de strangere M10

Avantaje:

- moment de torsiune controlat
- insurubare rapida
- o diversitate de utilizari

Utilizare

- industria auto
- industria aerospaciala
- echipament agricol
- industria grea
- constructia de masini
- industria de constructii navale
- montari individuale



UNIOR



55835

NOU

Masina de insurubat pneumatica cu impact 3/8" 610 Nm 11000 rpm

- cheile pneumatice cu impact EGA Master sunt proiectate pentru a furniza un cuplu ridicat cu efort minim din partea utilizatorului, in domeniul precum reparatiile auto, intretinerea echipamentelor grele, constructia majora a ansamblului de produse si pentru orice loc in care este nevoie de un cuplu ridicat
- motor conceput pentru a preveni pierderile de putere
- rotor cu arc care ofera putere mare de iesire
- carcasa compozita si usoara
- supapa speciala dintr-o singura bucată proiectata pentru intretinere usoara
- orificiu de aer pivotant la 360° care permite operatorului să se miste liber
- zgomot redus
- declansator cu sensibilitate ridicata pentru o functionare lina
- cuplu de strangere exact in fiecare pozitie

Pre Comanda



COMPOSITE

EGA Master
ART IN INNOVATION

615835	Cuplul de strangere	610 Nm / 450 ft-lb	2200	3191.31
	Cuplu maxim de strangere	610 Nm / 450 ft-lb		
	Cuplu maxim de slabire	610 Nm / 450 ft-lb		
	Consumul de aer	120 l/min		
	Admisie	1/4"		
	Nivelul de presiune a zgomotului	89,5 dBA		
	Nivel de putere de zgomot	100,5 dBA		
	Vibratii	5,4 m/s ²		
	Presiune de lucru	6,3 bari / 90 PSI		

1551

Antrenor reversibil pneumatic 1/2"

- viteza de rotatie 160 rot/min
- moment de torsiune max. 81 Nm
- presiunea maxima de aer comprimat: 6, 2 Bar
- consum de aer comprimat 113 l/min
- record de aer 1/4"
- capacitate maxima de strangere M10

Avantaje:

- scula mica si compacta
- calitatea productiei
- maner rotitor
- reglare rapida si usoara a sensului de rotatie
- supapa de protectie previne intrarea necontrolata a aerului in scula

Utilizare

- industria auto
- industria aerospaciala
- echipament agricol
- industria grea
- constructia de masini
- industria de constructii navale
- montari individuale

Important

- este recomandata folosirea capetelor de impact UNIOR



UNIOR



1552

Antrenor reversibil pneumatic 1/2"

- rulment cu ace
- cap clichet robust
- rulment cu bile
- maner anti alunecare
- regulator de aer model nou
- record aer pivotant la 360°
- evacuare din spate

Caracteristici tehnice:

- turatie mers in gol: 150 rpm
- patrat de antrenare: 1/2"
- cuplu maxim: 90 Nm
- record aer: 1/4"
- diametru recomandat furtun aer: 3/8"
- consum de aer: 113 l/min
- lungime: 256 mm
- greutate: 1,2 kg
- nivel de vibratii: 2,6 m/s²
- nivel de zgomot: 79 dB
- presiune aer recomandata: 6,2 bar

Utilizare

- industria auto, industria aerospaciala, echipament agricol, industria grea, constructia de masini, industria de constructii navale, montari individuale

Important

- este recomandata folosirea capetelor de impact UNIOR



UNIOR

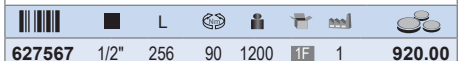

1563

Pistol pneumatic reversibil varianta Stubby 1/2"

- carcasa motorului din material compozit
- evacuarea prin maner (amortizorul de zgomot)
- schimbarea directiei de mers cu o singura mana
- compact si puternic

Caracteristici tehnice:

- turatie mers in gol: 8000 rpm
- patrat de antrenare: 1/2"
- cuplu maxim: 745 Nm
- cuplu maxim defacere: 1275 Nm
- record aer: 1/4"
- diametru recomandat furtun aer: 3/8"
- consum de aer: 164 l/min
- lungime: 98 mm
- greutate: 1,11 kg
- nivel de vibratii: 7,3 m/s²
- nivel de zgomot: 104 dB
- presiune aer recomandata: 6,2 bar

Utilizare

- industria auto, industria aerospaciala, echipament agricol, industria grea, constructia de masini, industria de constructii navale, montari individuale

Important

- este recomandata folosirea capetelor de impact UNIOR

UNIOR

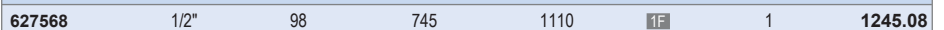

1564

Pistol pneumatic unghiular de impact 1/2"

- carcasa motorului din aluminiu
- maner din material compozit
- mecanism Jumbo Hammer
- schimbarea sensului se realizeaza cu o singura mana
- evacuarea prin maner (amortizor de zgomot)
- compact si puternic

Caracteristici tehnice:

- turatie mers in gol: 8000 rpm
- patrat de antrenare: 1/2"
- cuplu maxim: 343 Nm
- cuplu maxim desfacere: 536 Nm
- record aer: 1/4"
- diametru recomandat furtun aer: 3/8"
- consum de aer: 113 l/min
- lungime: 88 mm
- greutate: 1,16 kg
- nivel de vibratii: 9,96 m/s²
- nivel de zgomot: 92 dB
- presiune aer recomandata: 6,2 bar

Utilizare

- industria auto, industria aerospaciala, echipament agricol, industria grea, constructia de masini, industria de constructii navale, montari individuale

Important

- este recomandata folosirea capetelor de impact UNIOR



627569 1/2" 88 343 1160 1 1556.07

1561

Pistol pneumatic 1/2"

- viteza de rotatie 8000 rot/min
- moment de torsiune max. 814 Nm
- presiunea maxima de aer comprimat: 6, 2 Bar
- consum de aer comprimat 113 l/min
- racord de aer 1/4"
- capacitate maxima de strangere M16

Avantaje:

- moment de torsiune controlat
- insurubare rapida
- o diversitate de utilizari

Utilizare

- industria auto
- industria aerospaciala
- echipament agricol
- industria grea
- constructia de masini
- industria de constructii navale
- montari individuale

Important

- este recomandata folosirea capetelor de impact UNIOR



615322 1/2" 190 188 814 2910 1 1396.23

1565

Pistol pneumatic si set de capete chei tubulare 1/2" in cutie de plastic

- Dimensiunea cutiei : 346 x 292 x 83



615516 10 - 27 / 20 5600 1 2894.26

1561 (1/2"), 231.4/4 (1/2" x 125, 1/2" x 75), 231.8/4 (10 - 14, 15 - 32), 231/4 6p (10, 13, 17, 19, 21, 22, 24, 27), 1374 (50ml), 231/4L6p (17, 19, 21, 22, 24, 27)

1566

Pistol pneumatic reversibil de impact cu turatie variabila 1/2"

- carcasa motor din material compozit
- mecanism twin hammer
- schimbarea sensului se realizeaza cu o singura mana
- buton pentru schimbarea turatiei

Caracteristici tehnice:

- turatie mers in gol: 8000 rpm
- patrat de antrenare: 1/2"
- cuplu maxim: 1223 Nm
- cuplu maxim desfacere: 1756 Nm
- racord aer: 1/4"
- diametru recomandat furtun aer: 3/8"
- consum de aer: 113 l/min
- lungime: 187 mm
- greutate: 1,91 kg
- nivel de vibratii: 7,7 m/s²
- nivel de zgomot: 93 dB
- presiune aer recomandata: 6,2 bar

Utilizare

- industria auto, industria aerospaciala, echipament agricol, industria grea, constructia de masini, industria de constructii navale, montari individuale

Important

- este recomandata folosirea capetelor de impact UNIOR



Regulator aer
(3 trepte de viteza
Inainte / Inapoi)

Inapoi Inainte

schimbarea directiei de mers
cu o singura mana

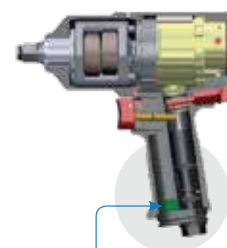

Amortizor pentru actionare silentioasa (optional)

627570 1/2" 187 1223 1191 1 1478.52

1562

Pistol pneumatic 1/2"

- viteza de rotatie 6500 rot/min
- moment de torsiune max. 949 Nm
- presiunea maxima de aer comprimat: 6, 2 Bar
- consum de aer comprimat 124 l/min
- racord de aer 1/4"
- capacitate maxima de strangere M18

Avantaje:

- moment de torsiune controlat
- insurubare rapida
- o diversitate de utilizari

Utilizare

- industria auto
- industria aerospaciala
- echipament agricol
- industria grea
- constructia de masini
- industria de constructii navale
- montari individuale



615321 1/2" 192 204 949 2800 1F 1 1757.38



55836

NOU

Masina de insurubat pneumatica cu impact 1/2" 680 Nm 11000 rpm**AVANTAJELE PRODUSULUI**

- cheile pneumatice cu impact EGA Master sunt proiectate pentru a furniza un cuplu ridicat cu efort minim din partea utilizatorului, in domenii precum reparatiile auto, intretinerea echipamentelor grele, constructia majora a ansamblului de produse si pentru orice loc in care este nevoie de un cuplu ridicat
- motor conceput pentru a preveni pierderile de putere
- rotor cu arc care ofera putere mare de iesire
- carcasa compozita si usoara
- supapa speciala dintr-o singura bucată proiectata pentru intretinere usoara
- orificiu de aer pivotant la 360° care permite operatorului să se miste liber
- zgomot redus
- declansator cu sensibilitate ridicata pentru o functionare lina
- mecanismul cu ciocan dublu de inalta performanta oferă o putere excelenta si o durabilitate ridicata
- schimbarea usoara a directiei
- cuplu de strangere exact in fiecare pozitie



55836	Cuplul de strangere	680 Nm / 500 ft-lb	2200	3191.31
	Cuplu maxim de strangere	680 Nm / 500 ft-lb		
	Cuplu maxim de slabire	680 Nm / 500 ft-lb		
	Pozitii imConsumul de aer	120 l/min		
	Admisie	1/4"		
	Nivelul de presiune a zgomotului	89,5 dBA		
	Nivel de putere de zgomot	100,5 dBA		
	Vibratii	5,2 m/s ²		
	Presiune de lucru	6,3 bari / 90 PSI		

55845

NOU

Masina de insurubat pneumatica cu impact 3/4" 1695 Nm 4000 rpm**AVANTAJELE PRODUSULUI**

- cheile pneumatice cu impact EGA Master sunt proiectate pentru a furniza un cuplu ridicat cu efort minim din partea utilizatorului, in domenii precum reparatiile auto, intretinerea echipamentelor grele, constructia majora a ansamblului de produse si pentru orice loc in care este nevoie de un cuplu ridicat
- motor conceput pentru a preveni pierderile de putere
- rotor cu arc care ofera putere mare de iesire
- carcasa compozita si usoara
- supapa speciala dintr-o singura bucată proiectata pentru intretinere usoara
- orificiu de aer pivotant la 360° care permite operatorului să se miste liber
- zgomot redus
- declansator cu sensibilitate ridicata pentru o functionare lina
- mecanismul cu ciocan dublu de inalta performanta oferă o putere excelenta si o durabilitate ridicata
- schimbarea usoara a directiei
- cuplu de strangere exact in fiecare pozitie



55845	Cuplul de strangere	680 Nm / 500 ft-lb	2200	7659.06
	Cuplu maxim de strangere	1560 Nm / 1150 ft-lb		
	Cuplu maxim de slabire	1628 Nm / 1200 ft-lb		
	Pozitii imConsumul de aer	170 l/min		
	Admisie	3/8"		
	Nivelul de presiune a zgomotului	90,8 dBA		
	Nivel de putere de zgomot	101,8 dBA		
	Vibratii	5,3 m/s ²		
	Presiune de lucru	6,3 bari / 90 PSI		

1571

Pistol pneumatic 3/4"

- viteza de rotatie 6500 rot/min
- moment de torsiune max. 1016 Nm
- presiunea maxima de aer comprimat: 6, 2 Bar
- consum de aer comprimat 198 l/min
- racord de aer 1/4"
- capacitate maxima de strangere M 24

Avantaje:

- moment de torsiune controlat
- insurubare rapida
- o diversitate de utilizari

Utilizare

- industria auto
- industria aerospaciala
- echipament agricol
- industria grea
- constructia de masini
- industria de constructii navale
- montari individuale

Important

- este recomandata folosirea capetelor de impact UNIOR



615324	3/4"	240	236	1085	4550	1F	1	3245.90
--------	------	-----	-----	------	------	----	---	---------

1575

Pistol pneumatic si set de capete chei tubulare 3/4" in cutie

- Dimensiunea cutiei : 393 x 331 x 95



617161	7	8330	1G	1	4378.69
--------	---	------	----	---	---------

1571 (3/4"), 232/4 6p (19, 24, 27, 32, 36, 41)

1573

Pistol pneumatic reversibil de impact cu turatie variabila 3/4"

- carcasa motor din material compozit
- mecanism twin hammer
- schimbarea sensului se realizeaza cu o singura mana
- buton pentru schimbarea turatiei

Caracteristici tehnice:

- turatie mers in gol: 5500 rpm
- patrat de antrenare: 3/4"
- cuplu maxim: 2034 Nm
- cuplu maxim desfacere: 3254 Nm
- racord aer: 3/8"
- diametru recomandat furtun aer: 1/2"
- consum de aer: 198 l/min
- lungime: 220 mm
- greutate: 3,44 kg
- nivel de vibratii: 11,6 m/s²
- nivel de zgomot: 93 dB
- presiune aer recomandata: 6,2 bar

Utilizare

- industria auto, industria aerospaciala, echipament agricol, industria grea, constructia de masini, industria de constructii navale, montari individuale

Important

- este recomandata folosirea capetelor de impact UNIOR



Regulator aer
(3 trepte de viteza Inainte / Inapoi)

Inapoi Inainte
schimbarea directiei de mers cu o singura mana



Amortizor pentru actionare silentioasa (optional)

UNIOR

627571 3/4" 220 2034 3440 1 3112.30

1591

Pistol pneumatic 1"

- viteza de rotatie 4000 rot/min
- moment de torsiune max. 2439 Nm
- presiunea maxima de aer comprimat: 6, 2 Bar
- consum de aer comprimat 255 l/min
- racord de aer 1/2"
- capacitate maxima de strangere M 36

Avantaje:

- moment de torsiune controlat
- insurubare rapida
- o diversitate de utilizari

Utilizare

- industria auto
- industria aerospaciala
- echipament agricol
- industria grea
- constructia de masini
- industria de constructii navale
- montari individuale

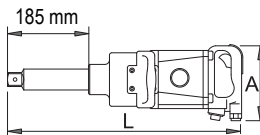

UNIOR

615325 1" 180 495 2439 13600 1 6471.80

1592

Pistol pneumatic 1"

- viteza de rotatie 4000 rot/min
- moment de torsiune max. 2439 Nm
- presiunea maxima de aer comprimat: 6, 2 Bar
- consum de aer comprimat 255 l/min
- racord de aer 1/2"
- capacitate maxima de strangere M 36

Avantaje:

- moment de torsiune controlat
- insurubare rapida
- o diversitate de utilizari

Utilizare

- industria auto
- industria aerospaciala
- echipament agricol
- industria grea
- constructia de masini
- industria de constructii navale
- montari individuale

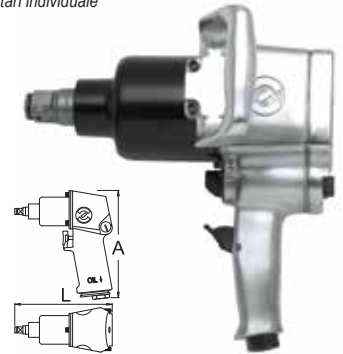

UNIOR

615326 1" 280 307 2439 12800 1 6471.8

56053

NOU

Masina de insurubat pneumatica cu impact 1" 3900 Nm 4000 rpm

AVANTAJELE PRODUSULUI

- cheile pneumatice cu impact EGA Master sunt proiectate pentru a furniza un cuplu ridicat cu efort minim din partea utilizatorului, in domenii precum reparatiile auto, intretinerea echipamentelor grele, constructia majora a ansamblului de produse si pentru orice loc in care este nevoie de un cuplu ridicat
- motor conceput pentru a preveni pierderile de putere
- rotor cu arc care ofera putere mare de iesire
- carcasa compozita si usoara
- supapa speciala dintr-o singura bucată proiectata pentru intretinere usoara
- orificiu de aer pivotant la 360° care permite operatorului să se miste liber
- zgomot redus
- declansator cu sensibilitate ridicata pentru o functionare lina
- mecanismul cu ciocan dublu de inalta performanta oferă o putere excelenta si o durabilitate ridicata
- schimbarea usoara a directiei
- cuplu de strangere exact in fiecare pozitie



EGAMaster
ART IN INNOVATION

Pre Comanda

	Cuplu de strangere		
56053	3900 Nm / 2876 ft-lb	10600	10889.13
	Cuplu maxim de strangere	3300 Nm / 2435 ft-lb	
	Cuplu maxim de slabire	3900 Nm / 2878 ft-lb	
	Pozitii imConsumul de aer	182 l/min	
	Admisie	1/2"	
	Nivelul de presiune a zgomotului	98 dBA	
	Nivel de putere de zgomot	109 dBA	
	Vibratii	6,9 m/s ²	
	Presiune de lucru	6,3 bari / 90 PSI	
	Nicovala extinsa	2"	

56054

NOU

Masina de insurubat pneumatica cu impact 1" 3900 Nm 4000 rpm

AVANTAJELE PRODUSULUI

- cheile pneumatice cu impact EGA Master sunt proiectate pentru a furniza un cuplu ridicat cu efort minim din partea utilizatorului, in domenii precum reparatiile auto, intretinerea echipamentelor grele, constructia majora a ansamblului de produse si pentru orice loc in care este nevoie de un cuplu ridicat
- motor conceput pentru a preveni pierderile de putere
- rotor cu arc care ofera putere mare de iesire
- carcasa compozita si usoara
- supapa speciala dintr-o singura bucată proiectata pentru intretinere usoara
- orificiu de aer pivotant la 360° care permite operatorului să se miste liber
- zgomot redus
- declansator cu sensibilitate ridicata pentru o functionare lina
- mecanismul cu ciocan dublu de inalta performanta oferă o putere excelenta si o durabilitate ridicata
- schimbarea usoara a directiei
- cuplu de strangere exact in fiecare pozitie



EGAMaster
ART IN INNOVATION

Pre Comanda

	Cuplu de strangere		
56054	3900 Nm / 2876 ft-lb	10600	12637.51
	Cuplu maxim de strangere	3300 Nm / 2435 ft-lb	
	Cuplu maxim de slabire	3900 Nm / 2878 ft-lb	
	Pozitii imConsumul de aer	182 l/min	
	Admisie	1/2"	
	Nivelul de presiune a zgomotului	98 dBA	
	Nivel de putere de zgomot	109 dBA	
	Vibratii	6,9 m/s ²	
	Presiune de lucru	6,3 bari / 90 PSI	
	Nicovala extinsa	8"	

1597

Ciocan pneumatic reversibil 1.1/2"

- viteza de rotatie 3000 rot/min
- moment de torsiune max. 4065 Nm
- presiunea maxima de aer comprimat: 6,2 Bar
- consum de aer comprimat 435 l/min
- racord de aer 1/2"
- capacitate maxima surub (piulita) M52

Avantaje:

- moment de torsiune controlat
- insurubare rapida
- o diversitate de utilizari

Utilizare

- industria auto
- industria aerospatiala
- echipament agricol
- industria grea
- constructia de masini
- industria de constructii navale
- montari individuale

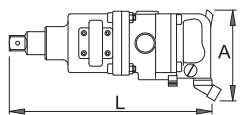

UNIOR

617691 1.1/2" 145 465 4065 18600 1 24478.20

1596

Ciocan pneumatic reversibil 1.1/2"

- viteza de rotatie 3000 rot/min
- moment de torsiune max. 3388 Nm
- presiunea maxima de aer comprimat: 6,2 Bar
- consum de aer comprimat 410 l/min
- racord de aer 1/2"
- capacitate maxima surub (piulita) M45

Avantaje:

- moment de torsiune controlat
- insurubare rapida
- o diversitate de utilizari

Utilizare

- industria auto
- industria aerospatiala
- echipament agricol
- industria grea
- constructia de masini
- industria de constructii navale
- montari individuale

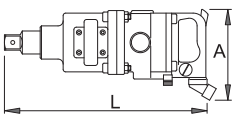

UNIOR

617690 1.1/2" 145 550 3388 17800 1 18384.10

NOU

Masina de insurubat pneumatica compacta la 90° cu hexagon 1/4" 4000 rpm

AVANTAJELE PRODUSULUI

- carcasa metalica, rezistenta la zgarieturi
- maner din plastic moale si robust
- reversibila inversand parghia de langa tragaci
- vibratii reduse, prevenind oboseala mainii in timpul operatiunilor lungi

EGAMaster
ART IN INNOVATION

Pre Comanda

Barcode	RPM	L	mm	kg	Price
58990	4000	240	104x27x16.5	650	6020.65
58992	4000	310	172x27x16.5	750	6978.09
Putere 0.22 kW					
Tutatii 4000 rpm					
Consumul de aer 238 LPM (10 CFM)					
Racord aer 1/4"					
Vibratii 2.5 m/s ²					
Presiune de lucru 6,3 bari / 90 PSI					
Nivel de zgomot 81,5 dBA					

NOU

Masina de insurubat pneumatica compacta la 45° cu hexagon 1/4" 4000 rpm

AVANTAJELE PRODUSULUI

- carcasa metalica, rezistenta la zgarieturi
- maner din plastic moale si robust
- reversibila inversand parghia de langa tragaci
- vibratii reduse, prevenind oboseala mainii in timpul operatiunilor lungi

EGAMaster
ART IN INNOVATION

Pre Comanda

Barcode	RPM	L	mm	kg	Price
58991	4000	260	120x31x16	650	6020.65
58993	4000	330	197x31x16	750	6978.09
Putere 0.22 kW					
Tutatii 4000 rpm					
Consumul de aer 283 LPM (10 CFM)					
Racord aer 1/4"					
Vibratii 2.5 m/s ²					
Presiune de lucru 6,3 bari / 90 PSI					
Nivel de zgomot 81,5 dBA					

NOU

Masina de insurubat pneumatica compacta la 90° cu hexagon 1/4" 3600 rpm

AVANTAJELE PRODUSULUI

- carcasa metalica, rezistenta la zgarieturi
- maner din plastic moale si robust
- reversibila inversand parghia de langa tragaci
- vibratii reduse, prevenind oboseala mainii in timpul operatiunilor lungi

EGAMaster
ART IN INNOVATION

Pre Comanda

Barcode	RPM	L	mm	kg	Price
58994	3600	260	104x27x16.5	900	7319.82
58996	3600	330	172x27x16.5	1000	8278.24
Putere 0.37 kW					
Tutatii 3600 rpm					
Consumul de aer 368 LPM (13 CFM)					
Racord aer 1/4"					
Vibratii 2.5 m/s ²					
Presiune de lucru 6,3 bari / 90 PSI					
Nivel de zgomot 80 dBA					

NOU

Masina de insurubat pneumatica compacta la 45° cu hexagon 1/4" 3600 rpm

AVANTAJELE PRODUSULUI

- carcasa metalica, rezistenta la zgarieturi
- maner din plastic moale si robust
- reversibila inversand parghia de langa tragaci
- vibratii reduse, prevenind oboseala mainii in timpul operatiunilor lungi

EGAMaster
ART IN INNOVATION

Pre Comanda

Barcode	RPM	L	mm	kg	Price
58995	3600	270	120x31x16	900	7319.82
58997	3600	350	197x31x16	1000	8278.24
Putere 0.37 kW					
Tutatii 3600 rpm					
Consumul de aer 368 LPM (13 CFM)					
Racord aer 1/4"					
Vibratii 2.5 m/s ²					
Presiune de lucru 6,3 bari / 90 PSI					
Nivel de zgomot 80 dBA					

NOU

Masina de insurubat pneumatica compacta la 90° cu mandrina 3 mm 1/8" 4000 rpm

AVANTAJELE PRODUSULUI

- carcasa metalica, rezistenta la zgarieturi
- maner din plastic moale si robust
- reversibila inversand parghia de langă tragaci
- vibratii reduse, prevenind oboseala mainii in timpul operatiunilor lungi



EGAMaster
ART IN INNOVATION

Pre Comanda

Barcode	RPM	L	mm	Weight	Price
59006	4000	240	104x69x16.5	750	6636.28
59008	4000	310	172x63x16.5	850	7593.79
		Putere	0.22 kW		
		Tutatii	4000 rpm		
		Consumul de aer	238 LPM (10 CFM)		
		Racord aer	1/4"		
		Vibratii	2,5 m/s ²		
		Presiune de lucru	6,3 bari / 90 PSI		
		Nivel de zgomot	81,5 dBA		

NOU

Masina de insurubat pneumatica compacta la 45° cu mandrina 3 mm 1/8" 4000 rpm

AVANTAJELE PRODUSULUI

- carcasa metalica, rezistenta la zgarieturi
- maner din plastic moale si robust
- reversibila inversand parghia de langă tragaci
- vibratii reduse, prevenind oboseala mainii in timpul operatiunilor lungi



EGAMaster
ART IN INNOVATION

Pre Comanda

Barcode	RPM	L	mm	Weight	Price
59007	4000	260	144x55x16	750	6020.65
59009	4000	330	221x55x16	850	6978.09
		Putere	0.22 kW		
		Tutatii	4000 rpm		
		Consumul de aer	283 LPM (10 CFM)		
		Racord aer	1/4"		
		Vibratii	2,5 m/s ²		
		Presiune de lucru	6,3 bari / 90 PSI		
		Nivel de zgomot	81,5 dBA		

NOU

Masina de insurubat pneumatica compacta la 90° cu bucsa 9/32" capacitate 5,9 mm - 3/16" 4000 rpm

AVANTAJELE PRODUSULUI

- carcasa metalica, rezistenta la zgarieturi
- maner din plastic moale si robust
- reversibila inversand parghia de langă tragaci
- vibratii reduse, prevenind oboseala mainii in timpul operatiunilor lungi



EGAMaster
ART IN INNOVATION

Pre Comanda

Barcode	RPM	L	mm	Weight	Price
58998	4000	240	104x31x16.5	650	6225.89
59000	4000	310	172x31x16.5	750	7183.40
		Putere	0.22 kW		
		Tutatii	4000 rpm		
		Consumul de aer	238 LPM (10 CFM)		
		Racord aer	1/4"		
		Vibratii	2,5 m/s ²		
		Presiune de lucru	6,3 bari / 90 PSI		
		Nivel de zgomot	81,5 dBA		

NOU

Masina de insurubat pneumatica compacta la 90° cu mandrina 3 mm 1/8" 3600 rpm

AVANTAJELE PRODUSULUI

- carcasa metalica, rezistenta la zgarieturi
- maner din plastic moale si robust
- reversibila inversand parghia de langă tragaci
- vibratii reduse, prevenind oboseala mainii in timpul operatiunilor lungi



EGAMaster
ART IN INNOVATION

Pre Comanda

Barcode	RPM	L	mm	Weight	Price
59010	3600	260	104x69x16.5	950	7935.52
59012	3600	330	172x63x16.5	1050	9099.27
		Putere	0.37 kW		
		Tutatii	3600 rpm		
		Consumul de aer	368 LPM (13 CFM)		
		Racord aer	1/4"		
		Vibratii	2,5 m/s ²		
		Presiune de lucru	6,3 bari / 90 PSI		
		Nivel de zgomot	80 dBA		

NOU

Masina de insurubat pneumatica compacta la 45° cu mandrina 3 mm 1/8" 3600 rpm

AVANTAJELE PRODUSULUI

- carcasa metalica, rezistenta la zgarieturi
- maner din plastic moale si robust
- reversibila inversand parghia de langă tragaci
- vibratii reduse, prevenind oboseala mainii in timpul operatiunilor lungi



EGAMaster
ART IN INNOVATION

Pre Comanda

Barcode	RPM	L	mm	Weight	Price
59011	3600	270	144x55x16	950	7935.52
59013	3600	350	221x55x16	1050	8894.03
		Putere	0.37 kW		
		Tutatii	3600 rpm		
		Consumul de aer	368 LPM (13 CFM)		
		Racord aer	1/4"		
		Vibratii	2,5 m/s ²		
		Presiune de lucru	6,3 bari / 90 PSI		
		Nivel de zgomot	80 dBA		

NOU

Masina de insurubat pneumatica compacta la 90° cu bucsa 9/32" capacitate 5,9 mm - 3/16" 3600 rpm

AVANTAJELE PRODUSULUI

- carcasa metalica, rezistenta la zgarieturi
- maner din plastic moale si robust
- reversibila inversand parghia de langă tragaci
- vibratii reduse, prevenind oboseala mainii in timpul operatiunilor lungi



EGAMaster
ART IN INNOVATION

Pre Comanda

Barcode	RPM	L	mm	Weight	Price
59002	3600	260	104x31x16.5	850	7525.13
59004	3600	330	172x31x16.5	950	8483.39
		Putere	0.37 kW		
		Tutatii	3600 rpm		
		Consumul de aer	368 LPM (13 CFM)		
		Racord aer	1/4"		
		Vibratii	2,5 m/s ²		
		Presiune de lucru	6,3 bari / 90 PSI		
		Nivel de zgomot	80 dBA		

NOU

Masina de insurubat pneumatica compacta la 45° cu bucsa 9/32" capacitate 5,9 mm - 3/16" 4000 rpm

AVANTAJELE PRODUSULUI

- carcasa metalica, rezistenta la zgarieturi
- maner din plastic moale si robust
- reversibila inversand parghia de langă tragaci
- vibratii reduse, prevenind oboseala mainii in timpul operatiunilor lungi



EGAMaster
ART IN INNOVATION

Pre Comanda

Barcode	RPM	L	mm	kg	Price
58999	4000	260	121x32x16	650	6225.89
59001	4000	330	198x32.5xd16	750	7183.40
Putere 0.22 kW					
Tutatii 4000 rpm					
Consumul de aer 283 LPM (10 CFM)					
Racord aer 1/4"					
Vibratii 2,5 m/s ²					
Presiune de lucru 6,3 bari / 90 PSI					
Nivel de zgomot 81,5 dBA					

58902**NOU**

Masina de insurubat pneumatica cu strangere controlata 3/8; 1,2-2,4 Nm

AVANTAJELE PRODUSULUI

- EGA Master produce o gama larga de scule pentru strangere controlata.
- noile masini pneumatice cu cuplu sunt proiectate pentru aplicatii in care este necesar un control precis al cuplului, chiar si in spatii inguste, oferind performanta maxima la fiecare lucrare
- corpul sculei extins pentru o operare confortabila si o forta de reactie mai mica
- reversibila, cu schimbarea sensului de rotatie
- gama larga de reglare a cuplului, de la 1,2 Nm la 70 Nm
- precizie ridicata: valoare CmK > 1,33 ± 10% la modelele tip unghi si precizie +/- 3% la modelul tip maner pistol
- reglare confortabila si simpla a cuplului, economisire mai mare de timp
- modele de tip maner unghi si pistol

ISO 5393

Pre Comanda



CE



EGAMaster
ART IN INNOVATION

Barcode	Cuplu de strangere	RPM	Price
58902	1,2-2,4 Nm	1200	6804.46
Cuplu strangere 1,2-2,4 Nm			
Tutatii 1450 rpm			
Consumul de aer 198 LPM (7 CFM)			
Admisie 1/4"			
Vibratii 2,5 m/s ²			
Presiune de lucru 6,3 bari / 90 PSI			
Lungime 340 mm			

58913**NOU**

Masina de insurubat pneumatica cu strangere controlata 3/8; 4-10 Nm

AVANTAJELE PRODUSULUI

- EGA Master produce o gama larga de scule pentru strangere controlata.
- noile masini pneumatice cu cuplu sunt proiectate pentru aplicatii in care este necesar un control precis al cuplului, chiar si in spatii inguste, oferind performanta maxima la fiecare lucrare
- corpul sculei extins pentru o operare confortabila si o forta de reactie mai mica
- reversibila, cu schimbarea sensului de rotatie
- gama larga de reglare a cuplului, de la 1,2 Nm la 70 Nm
- precizie ridicata: valoare CmK > 1,33 ± 10% la modelele tip unghi si precizie +/- 3% la modelul tip maner pistol
- reglare confortabila si simpla a cuplului, economisire mai mare de timp
- modele de tip maner unghi si pistol

ISO 5393

Pre Comanda



CE



EGAMaster
ART IN INNOVATION

Barcode	Cuplu de strangere	RPM	Price
58913	4-10 Nm	1300	10889.13
Cuplu strangere 4-10 Nm			
Tutatii 1450 rpm			
Consumul de aer 198 LPM (7 CFM)			
Admisie 1/4"			
Vibratii <2,5 m/s ²			
Presiune de lucru 6,3 bari / 90 PSI			
Lungime 350 mm			

NOU

Masina de insurubat pneumatica compacta la 45° cu bucsa 9/32" capacitate 5,9 mm - 3/16" 3600 rpm

AVANTAJELE PRODUSULUI

- carcasa metalica, rezistenta la zgarieturi
- maner din plastic moale si robust
- reversibila inversand parghia de langă tragaci
- vibratii reduse, prevenind oboseala mainii in timpul operatiunilor lungi



EGAMaster
ART IN INNOVATION

Pre Comanda

Barcode	RPM	L	mm	kg	Price
59003	3600	270	121x32x16	850	7525.13
59005	3600	350	198x32.5xd16	950	8483.39
Putere 0.37 kW					
Tutatii 3600 rpm					
Consumul de aer 368 LPM (13 CFM)					
Racord aer 1/4"					
Vibratii 2,5 m/s ²					
Presiune de lucru 6,3 bari / 90 PSI					
Nivel de zgomot 80 dBA					

58903**NOU**

Masina de insurubat pneumatica cu strangere controlata 3/8; 2,2-4,3 Nm

AVANTAJELE PRODUSULUI

- EGA Master produce o gama larga de scule pentru strangere controlata.
- noile masini pneumatice cu cuplu sunt proiectate pentru aplicatii in care este necesar un control precis al cuplului, chiar si in spatii inguste, oferind performanta maxima la fiecare lucrare
- corpul sculei extins pentru o operare confortabila si o forta de reactie mai mica
- reversibila, cu schimbarea sensului de rotatie
- gama larga de reglare a cuplului, de la 1,2 Nm la 70 Nm
- precizie ridicata: valoare CmK > 1,33 ± 10% la modelele tip unghi si precizie +/- 3% la modelul tip maner pistol
- reglare confortabila si simpla a cuplului, economisire mai mare de timp
- modele de tip maner unghi si pistol

ISO 5393

Pre Comanda



CE



EGAMaster
ART IN INNOVATION

Barcode	Cuplu de strangere	RPM	Price
58903	2,2-4,3 Nm	1200	6804.46
Cuplu strangere 2,2-4,3 Nm			
Tutatii 800 rpm			
Consumul de aer 198 LPM (7 CFM)			
Admisie 1/4"			
Vibratii 2,5 m/s ²			
Presiune de lucru 6,3 bari / 90 PSI			
Lungime 340 mm			

58914**NOU**

Masina de insurubat pneumatica cu strangere controlata 1/2; 10-40 Nm

AVANTAJELE PRODUSULUI

- EGA Master produce o gama larga de scule pentru strangere controlata.
- noile masini pneumatice cu cuplu sunt proiectate pentru aplicatii in care este necesar un control precis al cuplului, chiar si in spatii inguste, oferind performanta maxima la fiecare lucrare
- corpul sculei extins pentru o operare confortabila si o forta de reactie mai mica
- reversibila, cu schimbarea sensului de rotatie
- gama larga de reglare a cuplului, de la 1,2 Nm la 70 Nm
- precizie ridicata: valoare CmK > 1,33 ± 10% la modelele tip unghi si precizie +/- 3% la modelul tip maner pistol
- reglare confortabila si simpla a cuplului, economisire mai mare de timp
- modele de tip maner unghi si pistol

ISO 5393

Pre Comanda



CE



EGAMaster
ART IN INNOVATION

Barcode	Cuplu de strangere	RPM	Price
58914	10-40 Nm	2400	21964.14
Cuplu strangere 10-40 Nm			
Tutatii 280 rpm			
Consumul de aer 283 LPM (10 CFM)			
Admisie 1/4"			
Vibratii <2,5 m/s ²			
Presiune de lucru 5,9 bar / 85 PSI			
Lungime 520 mm			

58922

NOU

Masina de insurubat pneumatica cu strangere controlata 1/2; 35-70 Nm

AVANTAJELE PRODUSULUI

- EGA Master produce o gama larga de scule pentru strangere controlata.
- noile masini pneumatice cu cuplu sunt proiectate pentru aplicatii in care este necesar un control precis al cuplului, chiar si in spatii inguste, oferind performanta maxima la fiecare lucrare
- corpul sculei extins pentru o operare confortabila si o forta de reactie mai mica
- reversibila, cu schimbarea sensului de rotatie
- gama larga de reglare a cuplului, de la 1,2 Nm la 70 Nm
- precizie ridicata: valoare $CmK > 1,33 \pm 10\%$ la modelele tip unghi si precizie +/- 3% la modelul tip maner pistol
- reglare confortabila si simpla a cuplului, economisire mai mare de timp
- modele de tip maner unghi si pistol

ISO 5393

Pre Comanda



CE



ART IN INNOVATION

58922	Cuplu de strangere	2400	25086.01
	Cuplu strangere	35-70 Nm	
	Tutatii	130 rpm	
	Consumul de aer	283 LPM (10 CFM)	
	Admisie	1/4"	
	Vibratii	<2,5 m/s ²	
	Presiune de lucru	5,9 bar / 85 PSI	
	Lungime	520 mm	

58869

NOU

Pistol de insurubat pneumatic cu strangere controlata 3/8"; 5-28 Nm

AVANTAJELE PRODUSULUI

- EGA Master produce o gama larga de scule pentru strangere controlata.
- noile masini pneumatice cu cuplu sunt proiectate pentru aplicatii in care este necesar un control precis al cuplului, chiar si in spatii inguste, oferind performanta maxima la fiecare lucrare
- corpul sculei extins pentru o operare confortabila si o forta de reactie mai mica
- reversibila, cu schimbarea sensului de rotatie
- gama larga de reglare a cuplului, de la 1,2 Nm la 70 Nm
- precizie ridicata: valoare $CmK > 1,33 \pm 10\%$ la modelele tip unghi si precizie +/- 3% la modelul tip maner pistol
- reglare confortabila si simpla a cuplului, economisire mai mare de timp
- modele de tip maner unghi si pistol

ISO 5393



CE

Pre Comanda

ART IN INNOVATION

58869	Cuplu de strangere	1200	9181.81
	Cuplu strangere	5-28 Nm	
	Tutatii	280 rpm	
	Consumul de aer	550 LPM (17,7 CFM)	
	Admisie	1/4"	
	Vibratii	<2,5 m/s ²	
	Presiune de lucru	5,9 bar / 85 PSI	
	Dimensiuni	235x39x190 mm	

1515

Pistol de gaurire pneumatic

- cu schimbarea sensului de rotatie
- viteza de rotatie 1800 rotatii/minut
- presiunea maxima de aer comprimat: 6, 2 Bar
- consum de aer comprimat 113 l/min
- racord de aer 1/4"
- capacitate de prindere mandrina 1,0 - 10mm
- racord filetat 3/8", 24 UNF
- diametrul interior furtun 10mm

Avantaje:

- putere mare
- greutate mica, compact si usor de manevrat
- maner rotitor
- maner cu forma ergonomica pentru lucru fara efort
- maner protejat pentru micșorarea vibratiilor
- schimbare de sens
- sistem de schimbare rapida



617726	L	A	1360	1	756.39

1515H

Pistol pneumatic de gaurit cu maner lateral

- cu schimbarea sensului de rotatie
- viteza de rotatie 800 rotatii/minut
- presiunea maxima de aer comprimat: 6, 2 Bar
- consum de aer comprimat 113 l/min
- racord de aer 1/4"
- capacitate de prindere mandrina 1,5 - 13mm
- racord filetat 3/8", 24 UNF
- diametrul interior furtun 10mm

Avantaje:

- putere mare
- greutate mica, compact si usor de manevrat
- maner reglabil pentru o prindere buna
- maner rotitor
- maner cu forma ergonomica pentru lucru fara efort
- maner protejat pentru micșorarea vibratiilor
- schimbare de sens
- sistem de schimbare rapida



617727	L	A	1570	1	1216.56

57071

NOU

Surubelnita pneumatica HEX 1/4" 13 Nm

AVANTAJELE PRODUSULUI

- usor de utilizat datorita designului ergonomic si greutatii reduce
- nivel redus de zgomot
- consum redus de aer
- presiune de lucru de 6,3 bar
- declansator sensibil pentru o utilizare fina si precisa
- surubelnita dreapta cu regulator de viteza
- nivel redus de vibratii
- reversibila
- usor de utilizat cu o mana



CE

Pre Comanda

ART IN INNOVATION

57071	Cuplu de strangere	1100	2181.41
	Cuplu strangere	13 Nm	
	Tutatii	1800 rpm	
	Consumul de aer	113 LPM (4 CFM)	
	Admisie	1/4"	
	Vibratii	<2,5 m/s ²	
	Presiune de lucru	6,3 bar / 85 PSI	
	Nivel de zgomot	104,9 dBA	

57070

NOU

Surubelnita pneumatica HEX 1/4" 5-13 Nm

AVANTAJELE PRODUSULUI

- usor de utilizat datorita designului ergonomic si greutatii reduce
- nivel redus de zgomot
- consum redus de aer
- presiune de lucru de 6,3 bar
- declansator sensibil pentru o utilizare fina si precisa
- surubelnita dreapta cu regulator de viteza
- nivel redus de vibratii
- reversibila
- usor de utilizat cu o mana



CE

Pre Comanda

ART IN INNOVATION

57070	Cuplu de strangere	900	2772.66
	Cuplu strangere	5-13 Nm	
	Tutatii	1800 rpm	
	Consumul de aer	73 LPM (2,6 CFM)	
	Admisie	3/8"	
	Vibratii	<10,04 m/s ²	
	Presiune de lucru	6,3 bar / 85 PSI	
	Nivel de zgomot	102,5 dBA	

57073

NOU

Masina de gaurit pneumatica unghiulara 1800 rpm cu mandrina 10 mm

AVANTAJELE PRODUSULUI

- usor de utilizat datorita designului ergonomic si greutatii reduce
- nivel redus de zgomot
- consum redus de aer
- presiune de lucru de 6.3 bar
- nivel redus de vibratii
- reversibila
- usor de utilizat cu o mana



Pre Comanda

ART IN INNOVATION

57073	rpm	900	2029.14
	Putere	0,373 kW	
	Tutatii	1800 rpm	
	Capacitate mandrina	10 mm	
	Filet	3/8"-24	
	Diametru interior recomandat furtun	3/8"	
	Consumul de aer	80 LPM (2.8 CFM)	
	Racord aer	1/4"	
	Vibratii	<2,5 m/s ²	
	Presiune de lucru	6,3 bar / 85 PSI	
	Nivel de zgomot	90.5 dBA	

1516

Biax pneumatic drept

- viteza de rotatie 25000 rotatii/minut
- presiunea maxima de aer comprimat: 6.2 Bar
- consum de aer comprimat 113 l/min
- racord de aer 1/4"
- capacitate de prindere mandrina 6 mm
- diametrul interior furtun 10mm

Avantaje:

- levier de siguranta care previne pomirea accidentala
- prindere simpla a discurilor de slefuire si a celorlalte parti/extensii
- putere mare bazata pe marime
- scula mica si compacta
- reglare continua si variabila a rotatiei

Utilizare

- polizare precisa
- polizare completa
- scula industriala
- industria auto
- industria aerospatiala
- curatarea sudurii
- curatarea betonului si a suprafetelor de pereti
- curatirea suprafetelor de lemn
- inlaturarea vopselelor si a lacurilor
- inlaturarea ruginii
- curatire rulmenti
- curatire valve motor
- curatire pinioane si ambreiaje
- alte suprafete diverse

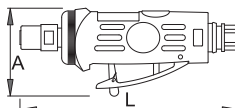

UNIOR

617731	L	A	390	1	703.28



1516A

Biax pneumatic unghiular

- viteza de rotatie 20000 rotatii/minut
- presiunea maxima de aer comprimat: 6.2 Bar
- consum de aer comprimat 113 l/min
- racord de aer 1/4"
- capacitate de prindere mandrina 6 mm
- diametrul interior furtun 10 mm

Avantaje:

- aceasta varianta unghiulara permite accesul in zone dificile in care in mod normal nu se poate face polizarea
- levier de siguranta care previne pomirea accidentala
- prindere simpla a discurilor de slefuire si a celorlalte parti/extensii
- putere mare bazata pe marime
- scula mica si compacta
- reglare continua si variabila a rotatiei

Utilizare

- polizare precisa
- polizare completa
- scula industriala
- industria auto
- industria aerospatiala
- curatarea sudurii
- curatarea betonului si a suprafetelor de pereti
- curatirea suprafetelor de lemn
- inlaturarea vopselelor si a lacurilor
- inlaturarea ruginii
- curatire rulmenti
- curatire valve motor
- curatire pinioane si ambreiaje
- alte suprafete diverse

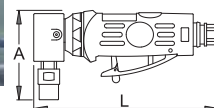

UNIOR

617732	L	A	740	1	911.64



57085

Capsator pneumatic 21



CE

ART IN INNOVATION

57085	Capacitate	900	2449.27
	Capacitate	155 capse	
	Capse	calibru 21	
	Presiune de lucru	6,3 bar / 90 PSI	
	Nivel vibratii	<2,5m/s ²	
	Nivel de zgomot	85,17 dBA	
	Racord aer	1/4"	
	Lungime	215 mm	
	Greutate	0,9 kg	

57078

NOU

Biax pneumatic drept 22000 rpm

• levier de siguranta care previne pomirea

Pre Comanda



CE

EGAMaster
ART IN INNOVATION

rpm	kg	Price
22000	600	1129.70
Consum de aer 80 LPM (2.8 CFM)		
Putere 0.373 kW		
Turatie mers in gol 22000 rpm		
Diametru penseta 6 mm		
Presiune de lucru 6.3 bar		
Nivel de zgomot 90.5 dBA		
Racord aer 1/4"		
Diametru interior recomandat furtun 3/8"		

57079

NOU

Biax pneumatic unghiular 18000 rpm

• levier de siguranta care previne pomirea

Pre Comanda



CE

EGAMaster
ART IN INNOVATION

rpm	kg	Price
18000	700	1602.97
Consum de aer 80 LPM (2.8 CFM)		
Putere 0.373 kW		
Turatie mers in gol 18000 rpm		
Diametru penseta 6 mm		
Presiune de lucru 6.3 bar		
Nivel de zgomot 77.3 dBA		
Racord aer 1/4"		
Diametru interior recomandat furtun 3/8"		

57099

NOU

Pistol pneumatic de gresat 400/450 g

• se utilizeaza cu vaselina la cartus sau vrac

Pre Comanda



CE

EGAMaster
ART IN INNOVATION

Capacitate	kg	Price
400g/450g	1400	1969.15
Presiune de lucru 4,1-10,3 bar / 60-150 PSI		
Nivel vibratii <2,5m/s ²		
Nivel de zgomot 74 dBA		
Consum aer 28 LPM / 1 CFM		
Lungimea nasului 150mm		
Presiune maxima livrata 410 bar / 6000 PSI		
Lungime 370 mm		
Greutate 0,9 kg		

1518

Polizor pneumatic unghiular

- viteza de rotatie 11000 rotatii/minut
- presiunea maxima de aer comprimat: 6,2 Bar
- consum de aer comprimat 170 l/min
- racord de aer 1/4"

Avantaje:

- maner interschimbabil
- levier de siguranta care previne pomirea accidentala

Utilizare

- protectia partilor in miscare
- folosit de asemenea in locuri inguste
- scula industriala
- curatarea sudurii
- curatarea betonului si a suprafetelor de pereti
- curatirea suprafetelor de lemn
- inlaturarea vopselelor si a lacurilor
- inlaturarea ruginii
- taiere profile si table
- alti utilizatori casnici



UNIOR

L	A	D	kg	Price
230	90	125	2175	1250.82

57081

NOU

Slefuitor pneumatic vertical 178 mm

- control in siguranta a vitezei
- nivel scazut de zgomot
- consum redus de aer



Pre Comanda

CE

EGAMaster
ART IN INNOVATION

Pad	kg	Price
178 mm	3200	8405.73
Presiune de lucru 6,3 bar / 90 PSI		
Racord aer 3/8"		
Nivel vibratii 8,3 m/s ²		
Nivel de zgomot 86,9 dBA		
Consum aer 127 LPM (4,5 CFM)		
Filet 5/8"-11		
Pad 178 mm		
Turatie mers in gol 7000 rpm		
Putere 1,7 kW		
Diametru furtun aer comprimat 3/8"		
Lungime 180 mm		
Greutate 3,2 kg		

57080

NOU

Polizor pneumatic unghiular 125 mm

- control in siguranta a vitezei
- nivel scazut de zgomot
- consum redus de aer



Pre Comanda

CE

EGAMaster
ART IN INNOVATION

Disc	kg	Price
125 mm	2105	7092.93
Presiune de lucru 6,3 bar / 90 PSI		
Racord aer 1/4"		
Nivel vibratii 7,7 m/s ²		
Nivel de zgomot 94,8 dBA		
Consum aer 98 LPM (3,5 CFM)		
Filet M14		
Diametru disc 125 mm		
Turatie mers in gol 11000 rpm		
Putere 1,7 kW		
Diametru furtun aer comprimat 3/8"		
Lungime 180 mm		
Greutate 3,2 kg		



57075

NOU

Slefuitor pneumatic orbital 6" - 2.5 mm

- sac de praf inclus



Pre Comanda

CE

EGAMaster
ART IN INNOVATION

Capacitate	kg	Price
6" - 2.5 mm	850	3933.76
Presiune de lucru 6,3 bar / 90 PSI		
Racord aer 1/4"		
Nivel vibratii 3,7 m/s ²		
Nivel de zgomot 77,2 dBA		
Consum aer 62 LPM (2,2 CFM)		
Filet 5/16"-24		
Pad 150 mm (6")		
Orbita 2,5 mm		
Turatie mers in gol 12000 rpm		
Putere 0,22 kW		
Diametru furtun aer comprimat 3/8"		
Lungime 150 mm		
Greutate 0,85 kg		

57074

NOU

Slefuitor pneumatic orbital 6" - 5.0 mm

• sac de praf inclus



Pre Comanda

CE

EGAMaster
ART IN INNOVATION

57074	Capacitate	950	4114.62
6" - 5.0 mm			
Presiune de lucru	6,3 bar / 90 PSI		
Racord aer	1/4"		
Nivel vibratii	4,5 m/s ²		
Nivel de zgomot	85,2 dBA		
Consum aer	62 LPM (2,2 CFM)		
Filet	5/16"-24		
Pad	150 mm (6")		
Orbita	5.0 mm		
Turatie mers in gol	12000 rpm		
Putere	0.22 kW		
Diametru furtun aer comprimat	3/8"		
Lungime	215 mm		
Greutate	0,95 kg		

1517S

Masina pneumatica de slefuit

- viteza de rotatie 4500 rotatii/minut
- presiunea maxima de aer comprimat: 6,2 Bar
- consum de aer comprimat 340 l/min
- racord de aer 1/4"
- racord filetat 5/8"

Avantaje:

- scula mica si compacta
- utilizabil atat pentru mana dreapta cat si pentru mana stanga
- maner interschimbabil
- maner rotitor

Utilizare

- curatirea sudurii
- curatirea znelor ascutite
- curatirea suprafetelor mici accidentate

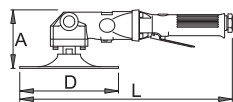

UNIOR

57074	L	A	D	950	4114.62
617729	375	100	175	2610	1319.34

57076

NOU

Slefuitor pneumatic cu banda 10x330

- nivel de zgomot redus
- clapeta de reglarea nivelului de zgomot
- maner reglabil apatabil pentru orice pozitie de lucru 360
- ideal pentru lucru la piese mici
- 3 benzi de slefuire incluse

Pre Comanda



CE

EGAMaster
ART IN INNOVATION

57076	Banda	850	2455.55
Banda (3 bucati incluse)	10x330mm (1pc-80gr / 2pcs-120gr)		
Presiune de lucru	6,3bar / 90PSI		
Racord aer	1/4"		
Nivel vibratii	2,5 m/s ²		
Nivel de zgomot	82,4 dBA		
Consum aer	80LPM (2.8CFM)		
Putere	0.28 kW		
Diametru furtun aer comprimat	3/8"		
Lungime	260mm		
Greutate	0,9 kg		

1510

Masina pneumatica de slefuit

- viteza de rotatie 1000 rotatii/minut
- presiunea maxima de aer comprimat: 6, 2 Bar
- consum de aer comprimat 368 l/min
- racord de aer 1/4"

Avantaje:

- forma ergonomica a manerului asigura o prindere ferma si impiedica alunecarea
- utilizabil atat pentru mana dreapta cat si pentru mana stanga
- silentios si usor de manevrat
- buton manual de on/off
- exhaustarea particulelor intr-un sac pentru o suprafata de lucru curata.
- furtun robust si flexibil pentru curatirea prafului
- nu sunt permise colturi pe suprafata de lucru
- conditii mai bune de lucru datorita vibratiilor minime
- putere mare bazata pe greutate (1.2 kg)

Utilizare

- ateliere de tinichigerie
- pregatirea diferitelor suprafete de lucru pentru operatiile ulterioare
- ideal pentru slefuirea suprafetelor metalice, metale si lemn
- platan slefuitorului este VELCRO™ sistem care asigura slefuirea simpla, usoara, rapida si in siguranta a diferitelor parti de slefuit. Sistemul este utilizat pentru diverse ocazii, cel mai cunoscut exemplu pantofii de sport cu sistem VELCRO™



UNIOR

57076	Nº	L	A	D	850	2455.55
617733	2.5	220	105	150	1600	2249.51
617713	5	220	105	150	1615	2312.95

57077

NOU

Slefuitor pneumatic cu banda 20x520

- nivel de zgomot redus
- clapeta de reglarea nivelului de zgomot
- maner reglabil apatabil pentru orice pozitie de lucru 360
- ideal pentru lucru la piese mici
- 3 benzi de slefuire incluse

Pre Comanda



CE

EGAMaster
ART IN INNOVATION

57077	Banda	1200	4025.47
Banda (3 bucati incluse)	20x520mm (1pc-80gr / 2pcs-120gr)		
Presiune de lucru	6,3bar / 90PSI		
Racord aer	1/4"		
Nivel vibratii	2,5 m/s ²		
Nivel de zgomot	84,4 dBA		
Consum aer	80LPM (2.8CFM)		
Putere	0.373 kW		
Diametru furtun aer comprimat	3/8"		
Lungime	340 mm		
Greutate	1200 kg		

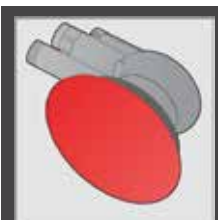

Masina pneumatica de slefuit



forma ergonomica a manerului asigura o prindere ferma si impiedica alunecarea



exhaustarea particulelor intr-un sac pentru o suprafata de lucru curata.



buton manual de on/off

1514PB

Pistol pneumatic daltuitor cu set de dalti

• Dimensiunea cutiei : 307 x 260 x 70



UNIOR

619964 7 3210 1G 1 1200.49

1514 (170), 1514A1 (182), 1514A2 (180), 1514A3 (180), 1514A4 (180), 1514A5 (190), 1514A6 (178), 981PBM2 (307 x 260 x 74)

1514

Pistol pneumatic daltuitor

- utilizat pentru taierea tablelor, bolturilor si curatirea suprafetelor sudate, nituri, ipsos si tigle
- cu arc, inlocuire rapida ca parte de schimb
- piston percutor lungime: 70 - 67mm, 225 - 92mm
- diametrul interior 9,1mm
- lovituri pe minut: 170 - 3000, 225 - 2100
- consum de aer comprimat 250 l/min
- Racord de aer 1/4"

Avantaje:

- scula usoara si compacta, folosita de asemenea in camere mici
- o diversitate de utilizari
- sistem de retinere

Utilizare

- industria auto
- taierea bucatilor de metal si a suruburilor
- inlaturarea cordoanelor de sudura
- lucrul la pereti, beton, piatra, caramida, otel, met ale usoare

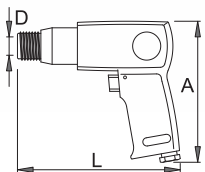

UNIOR

617714 170 150 19 1810 1F 1 678.69
617715 225 150 19 2160 1F 1 799.34

1514.1

Arc pentru 1514



UNIOR

617716 69 1E 1 58.52

1514.2

Dispozitiv de schimbare rapida pentru 1514

- pentru fixarea/demontarea simpla si rapida a daltii
- schimbare rapida cu actionarea inelului de deblocare superior
- inel de deblocare striat pentru o priza maximala la schimbarea sculei



UNIOR

617717 351 1F 1 161.97

1514A3

Dalta pentru nituri si curatat sudura

Utilizare

- pentru a inlatura niturile si zgura de sudura

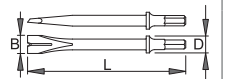

UNIOR

617720 180 20 19 179 1E 1 55.90

1514A4

Dalta pentru taiat tabla

Utilizare

- pentru taierea tablelor

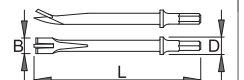

UNIOR

617721 180 16.7 19 178 1E 1 55.90

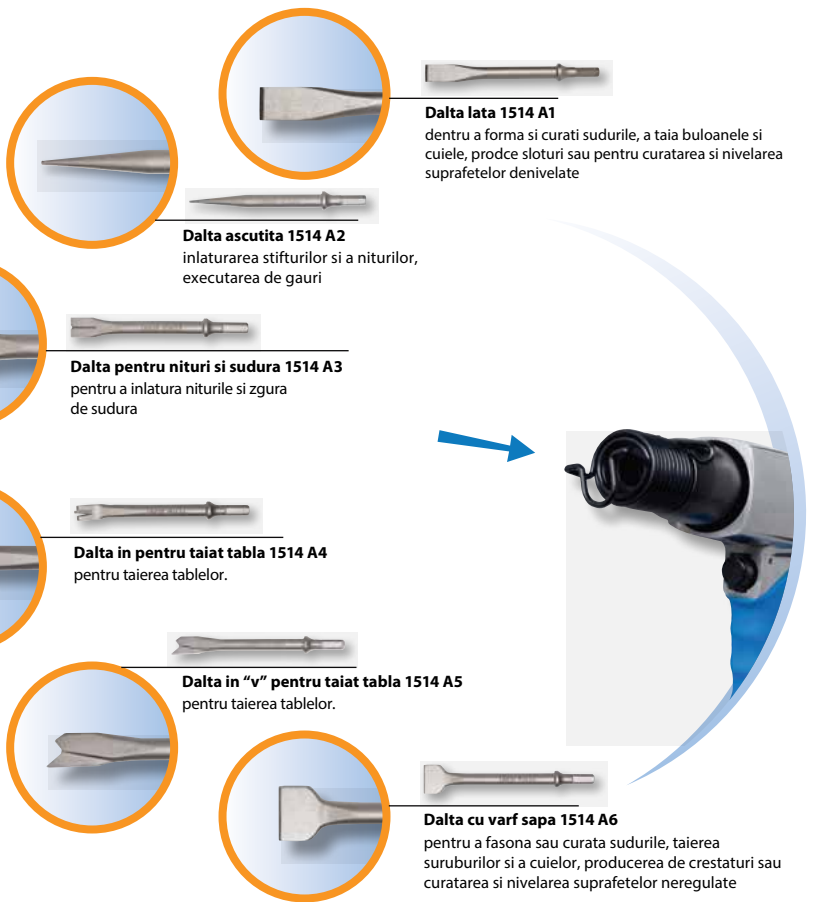

1514A1

Dalta lata

Utilizare

- Pentru a forma si curati sudurile, a taia buloanele si ciucile, prodce sloturi sau pentru curatarea si nivelarea suprafetelor denivelate.

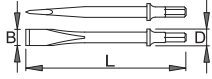

UNIOR

617718	182	18	19	181	1E	1	55.90
--------	-----	----	----	-----	----	---	-------

1514A2

Dalta ascutita

Utilizare

- Inlaturarea stifturilor si a niturilor, darea de gauri



UNIOR

617719	180	2	19	154	1E	1	55.90
--------	-----	---	----	-----	----	---	-------

1514A5

Dalta cu varf in V

Utilizare

- pentru taierea tablelor

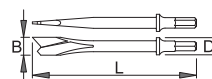

UNIOR

617722	190	19.2	19	187	1E	1	55.90
--------	-----	------	----	-----	----	---	-------

1514A6

Dalta cu varf sapa

Utilizare

- Pentru a fasona sau curata sudurile, taierea suruburilor si a ciucilor, producerea de crestaturi sau curatarea si nivelarea suprafetelor neregulate

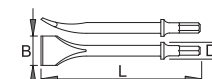

UNIOR

617723	178	32.8	19	207	1E	1	55.90
--------	-----	------	----	-----	----	---	-------

57082

NOU

Daltuitor pneumatic 3500 rpm

- declansator sensibil pentru performanta si acuratete
- nivel de zgomot redus
- consum redus de aer
- arc de retentie dalti
- regulator putere



Pre Comanda

CE

EG
ART IN INNOVATION

57082	RPM	3500	2000	830.53
	Presiune de lucru	6,3 bar / 90 PSI		
	Racord aer	1/4"		
	Nivel vibratii	15 m/s ²		
	Nivel de zgomot	103 dBA		
	Consum aer	56 LPM (2 CFM)		
	Gaura	19 mm		
	Coadă hexagonală	10 mm		
	Turatie mers in gol	3500 rpm		
	Cursa piston	66 mm		
	Diametru furtun aer comprimat	3/8"		
	Lungime	170mm		
	Greutate	2.0 kg		

57082

NOU

Dalti pentru daltuitor pneumatic

- material: oțel 50-55 HRc

Pre Comanda

EG
ART IN INNOVATION

	Tip		
87946	Dalta lata 7" hex. 10 mm		103.61
87948	Dalta ascutita 7" hex. 10 mm		103.61
87950	Dalta sudura si imbinati 7" hex. 10 mm		103.61
87947	Dalta cu 2 taisuri 7" hex. 10 mm		103.61
87949	Dalta tip V 7" hex. 10 mm		103.61

57083

NOU

Fierastrau sabie pneumatic 10000 rpm

- reglare aparatorii lamelor pentru ajustarea adancimii de taiere
- nivel de zgomot redus
- consum redus de aer
- regulator putere



CE

EG
ART IN INNOVATION

Pre Comanda

57083	RPM	10000	1000	1587.77
	Presiune de lucru	6,3 bar / 90 PSI		
	Racord aer	1/4"		
	Nivel vibratii	19,7 m/s ²		
	Nivel de zgomot	85,7 dBA		
	Consum aer	113 LPM (4 CFM)		
	Panze incluse	1pc-24T / 1pc-32T		
	Turatie mers in gol	10000 rpm		
	Cursa	10 mm		
	Diametru furtun aer comprimat	3/8"		
	Lungime	235 mm		
	Greutate	1,0 kg		

57084

NOU

Scula pneumatica pentru indepartat parbrize 20000 rpm

- reglare aparatorii lamelor pentru ajustarea adancimii de taiere
- nivel de zgomot redus
- consum redus de aer
- lama oscilatorie

Pre Comanda

EG
ART IN INNOVATION

CE

57084	RPM	20000	1000	2255.52
	Presiune de lucru	6,3 bar / 90 PSI		
	Racord aer	1/4"		
	Nivel vibratii	7,9 m/s ²		
	Nivel de zgomot	95,5 dBA		
	Consum aer	110LPM (3.9CFM)		
	Putere	0,37 kW		
	Turatie mers in gol	20000 rpm		
	Diametru furtun aer comprimat	3/8"		
	Lungime	205 mm		
	Greutate	1,0 kg		



87953

NOU

Lama pentru indepartat parbrize

Pre Comanda

EG
ART IN INNOVATION

87953	RPM	20000	350	146.66
-------	-----	-------	-----	--------

57146

NOU

Nituitor pneumatic 2,4 - 3,2 - 4,0 - 4,8

AVANTAJELE PRODUSULUI

- usor de utilizat datorita designului ergonomic si greutatii reduse
- nivel redus de zgomot
- consum redus de aer
- presiune de lucru de 6,3 bar
- declansator sensibil pentru o utilizare fina si precisa
- surubelnita dreapta cu regulator de viteza
- nivel redus de vibratii
- reversibila
- usor de utilizat cu o mana



CE

EGAMaster
ART IN INNOVATION

Pre Comanda

Capacitate		
57146	2,4 - 3,2 - 4,0 - 4,8	1500 1864.63
Nituri	2,4 - 3,2 - 4,0 - 4,8	
Putere tragere	880 kg	
Cursa	14 mm	
Capacitate	4,8 mm (3/16")	
Presiune de lucru	6,3 bar / 90 PSI	
Nivel vibratii	<2,5m/s ²	
Nivel de zgomot	88,8 dBA	
Racord aer	1/4"	
Lungime	270 mm	
Greutate	1.5 kg	

57147

NOU

Nituitor pneumatic 2,4 - 3,2 - 4,0 - 4,8 - 6,4

AVANTAJELE PRODUSULUI

- usor de utilizat datorita designului ergonomic si greutatii reduse
- nivel redus de zgomot
- consum redus de aer
- presiune de lucru de 6,3 bar
- declansator sensibil pentru o utilizare fina si precisa
- surubelnita dreapta cu regulator de viteza
- nivel redus de vibratii
- reversibila
- usor de utilizat cu o mana



CE

EGAMaster
ART IN INNOVATION

Pre Comanda

Capacitate		
57147	2,4 - 3,2 - 4,0 - 4,8 - 6,4	2100 4713.23
Nituri	2,4 - 3,2 - 4,0 - 4,8 - 6,4	
Putere tragere	1400 kg	
Cursa	19 mm	
Capacitate	6,4 mm (1/4")	
Presiune de lucru	6,3 bar / 90 PSI	
Nivel vibratii	<2,5m/s ²	
Nivel de zgomot	92,1 dBA	
Racord aer	1/4"	
Lungime	325 mm	
Greutate	2.1 kg	

1508A

Pistol de curatire pneumatic

- presiunea maxima de aer comprimat: 10,9 bar
- consum de aer comprimat 220 l/min

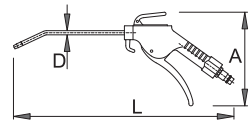

UNIOR

L	A	D				
617767	260	135	6	153	1E	10 63.61

1508B

Pistol pneumatic de curatire lung

- presiunea maxima de aer comprimat: 10,9
- consum de aer comprimat 220 l/min

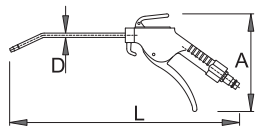

UNIOR

L	A	D				
617768	420	135	6	178	1E	10 90.66

55842

NOU

Pistol pneumatic de curatire

- presiunea maxima de aer comprimat: 1 Mpa (10 bar)

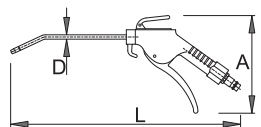

Pre Comanda

EGAMaster
ART IN INNOVATION

L1	A	D				
55842	100	135	6	80	1E	10 102.12

1500

Filtru regulator si ungator pneumatic 1/4"

- racord de aer 1/4"
- presiune maxima de aer comprimat: 9,5 Bar
- debit maxim 600 l/min
- presiunea de lucru 0,5 - 8,5 Bar
- temperatura de lucru 5 - 60 °C
- grad de filtrare 5 microni
- capacitate filtru 15ml
- capacitate lubrifiant 25ml

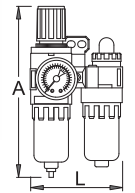

UNIOR

L	A				
617735	90	155	491	1E	1 628.03

1500C

Set de pahare pentru 1500



UNIOR

617738	71			1E	1 156.89

1501

Filtru regulator si ungator pneumatic 3/8"

- racord de aer 3/8"
- presiune maxima de aer comprimat: 9,5 Bar
- debit maxim 1800 l/min
- presiunea de lucru 0,5 - 8,5 Bar
- temperatura de lucru 5 - 60 °C
- grad de filtrare 5 microni
- capacitate filtru 60ml
- capacitate ungator 90ml

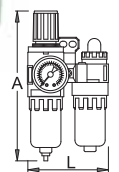

UNIOR

L	A				
617736	150	220	1285	1E	1 920.16

1502

Filtru regulator si ungator pneumatic 1/2"

- racord de aer 1/2"
- presiune maxima de aer comprimat: 9,5 Bar
- presiunea de lucru 0,5 - 8,5 Bar
- temperatura de lucru 5 - 60 °C
- grad de filtrare 5 microni
- debit maxim 2300 l/min
- capacitate filtru 60ml
- capacitate ungator 90ml

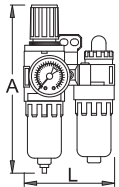

UNIOR

Barcode	L	A	Weight	Material	Quantity	Price
617737	150	220	1265	1E	1	1016.89

1503

Filtru regulator si gresor pneumatic 3/4"

- racord aer 3/4"
- presiune maxima de aer comprimat: 9,5 Bar
- presiunea de lucru 0,5 - 8,5 Bar
- temperatura de lucru 5 - 60 °C
- grad de filtrare 5 microni
- debit maxim 2500 l/min
- capacitate filtru 60ml
- capacitate ungator 90ml

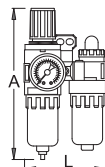

UNIOR

Barcode	L	A	Weight	Material	Quantity	Price
621473	190	240	1805	1E	1	1173.44

1500PG

Manometru de presiune pentru 1500



UNIOR

Barcode	Weight	Material	Quantity	Price
617741	63	1E	1	68.03

1501PG

Manometru de presiune pentru 1501 in 1502



UNIOR

Barcode	Weight	Material	Quantity	Price
617742	16	1E	1	80.16

1505

Furtun pneumatic elicoidal

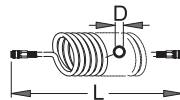

UNIOR

Barcode	L (m)	D	Weight	Material	Quantity	Price
617743	9	6.5 x 10	850	1E	1	194.43
617744	9	8 x 12	894	1E	1	237.54
617745	9	11 x 16	1526	1E	1	388.69
617746	12	6.5 x 10	835	1E	1	299.34
617747	12	8 x 12	1076	1E	1	378.69
617748	12	11 x 16	1847	1E	1	504.10

58682

Tambur 15 m furtun pneumatic 1/4" diametru interior furtun ø 3/8"

Pre Comanda

EGAMaster
ART IN INNOVATION

Barcode	Weight	Material	Quantity	Price
58682	5850	1E	1	2425.40

55843

NOU

Tambur 15 m furtun pneumatic 1/4" diametru interior furtun ø 3/8"

Pre Comanda

EGAMaster
ART IN INNOVATION

Barcode	Weight	Material	Quantity	Price
55843	5850	1E	1	2425.40

1506KZ7

Cuplaj cu filet exterior

- carcasa metalica
- filet exterior

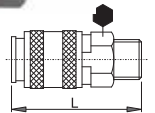

UNIOR

Barcode	Material	L	Weight	Material	Quantity	Price	
617793	R1/4"	20	58	98	1E	1	63.93
617794	R3/8"	20	54	101	1E	1	65.41

1506KZ10

Cuplaj cu filet exterior

- carcasa metalica
- filet exterior

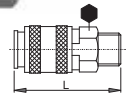

UNIOR

Barcode	Material	L	Weight	Material	Quantity	Price	
621452	3/8"	24	62.5	149	1E	1	192.95
621453	1/2"	24	65.0	156	1E	1	192.95
621454	3/4"	27	67.1	191	1E	1	216.23

1506KN7

Cuplaj cu filet interior

- carcasa metalica
- filet interior

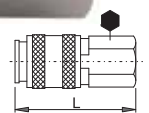
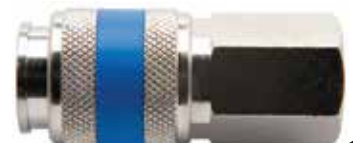

UNIOR

Barcode	Material	L	Weight	Material	Quantity	Price	
617795	R1/4"	20	54.5	113	1E	1	66.56
617796	R3/8"	20	55	105	1E	1	66.56

1506PZ**Cuplaj cu filet exterior**

- carcasa de plastic
- filet exterior

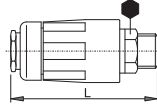

UNIOR

617789	R3/8"	19	70	137	1E	1	213.61

1507Z7**Cuplaj cu filet exterior**

- diametrul interior furtun $\varnothing 7\text{mm}$
- filet exterior

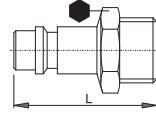

UNIOR

617797	R1/4"	14	34	24	1E	1	14.43
617798	R3/8"	19	36.5	34	1E	1	16.07
618483	R1/2"	22	39	40	1E	1	24.75

1507Z10**Cuplaj cu filet exterior**

- filet exterior
- diametrul furtunului interior 10mm

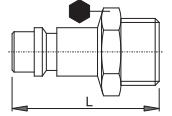

UNIOR

621455	3/8"	17	39.4	38	1E	1	38.52
621456	1/2"	24	39.4	53	1E	1	45.74
621457	3/4"	27	48.5	86	1E	1	63.28

MASTEREX 79602

NOU

Masina de gaurit pneumatica mandrina max. 10mm 1550 rpm

- EGA Master ofera o gama larga de unelte si instrumente intrinsec sigure pentru utilizare in zone periculoase. Printre acestea compania produce masini de gaurit pneumatice, ideal pentru foraj in zone explozive
- masina de gaurit este perfecta pentru majoritatea lucrarilor de foraj in zone periculoase
- universala
- cu reducerea optima a zgomotului.
- putere: 500 W
- maner ergonomic

Pre Comanda



ZONE M2 MINIERE

EGA Master
ART IN INNOVATION

79602	RPM	2100	20127.86
Presiune de lucru	6 bar		
Capacitate mandrina	10 mm		
Capacitate maxima gaurire in otel	10 mm		
Turatie mers in gol	1550 rpm		
Putere motor	0.500 kW		
Racorduri	1/4"		
Diamentru interior recomandat furtun	10 mm		
Nivel zgomot	84 dB		
Nivel vibratii	<2,5 m/s ²		
Lungime	230 mm		
Marcaje ATEX	EX I M2 Ex h I Mb T6		
Greutate	2100 kg		

MASTEREX 36808

NOU

Masina de gaurit pneumatica mandrina max. 13 mm

- EGA Master ofera o gama larga de unelte si instrumente intrinsec sigure pentru utilizare in zone periculoase. Printre acestea compania produce masini de gaurit pneumatice, ideal pentru foraj in zone explozive
- masina de gaurit este perfecta pentru majoritatea lucrarilor de foraj in zone periculoase
- universala
- cu reducerea optima a zgomotului.
- putere: 1 kW
- maner ergonomic

Pre Comanda



ZONE 1, 2 GAZ

EGA Master
ART IN INNOVATION

36808	RPM	3700	30516.39
Presiune de lucru	6 bar		
Capacitate mandrina	13 mm		
Capacitate maxima gaurire in otel	30 mm		
Turatie mers in gol	450/650/850/1000 rpm		
Putere motor	1 kW		
Consum aer	1.15 m ³ /min		
Racorduri	1/4"		
Diamentru interior recomandat furtun	10 mm		
Nivel zgomot	84 dB		
Nivel vibratii	<2,5 m/s ²		
Lungime	230 mm		
Marcaje ATEX	EX II 2G Ex h IIB T5 Gb		
Greutate	3700 kg		

MASTEREX 79605

NOU

Masina de gaurit pneumatica mandrina rapida, cuplu max. 9 Nm

- EGA Master ofera o gama larga de unelte si instrumente intrinsec sigure pentru utilizare in zone periculoase. Printre acestea compania produce masini de gaurit pneumatice, ideal pentru foraj in zone explozive
- masina de gaurit este perfecta pentru majoritatea lucrarilor de foraj in zone periculoase
- universala
- cu reducerea optima a zgomotului.
- putere: 650 W
- maner tip D

Pre Comanda



ZONE M2 MINIERE

EGA Master
ART IN INNOVATION

79605	RPM	5700	30083.45
Presiune de lucru	6 bar		
Capacitate mandrina	Madrina Actionare Rapida		
Capacitate maxima gaurire in otel	13 mm		
Turatie mers in gol	650 rpm		
Putere motor	0.65 kW		
Consum aer	0.68 m ³ /min		
Racorduri	R 3/8" f		
Diamentru interior recomandat furtun	13 mm		
Nivel zgomot	89 dB		
Nivel vibratii	<2,5 m/s ²		
Marcaje ATEX	EX I M2 Ex h I Mb T6		
Greutate	5700 kg		

MASTEREX 79603

NOU

Masina de gaurit pneumatica mandrina max. 13mm 850 rpm

- EGA Master ofera o gama larga de unelte si instrumente intrinsec sigure pentru utilizare in zone periculoase. Printre acestea compania produce masini de gaurit pneumatice, ideal pentru foraj in zone explozive
- masina de gaurit este perfecta pentru majoritatea lucrarilor de foraj in zone periculoase
- universala
- cu reducerea optima a zgomotului.
- putere: 500 W
- maner ergonomic

Pre Comanda



ZONE M2 MINIERE

EGA Master
ART IN INNOVATION

79603	RPM	2100	26981.37
Presiune de lucru	6 bar		
Capacitate mandrina	13 mm		
Capacitate maxima gaurire in otel	13 mm		
Turatie mers in gol	850 rpm		
Putere motor	0.500 kW		
Racorduri	1/4"		
Diamentru interior recomandat furtun	10 mm		
Nivel zgomot	84 dB		
Nivel vibratii	<2,5 m/s ²		
Lungime	230 mm		
Marcaje ATEX	EX I M2 Ex h I Mb T6		
Greutate	2100 kg		

MASTEREX 79904

NOU

Masina de gaurit pneumatica mandrina max. 13 mm

- EGA Master ofera o gama larga de unelte si instrumente intrinsec sigure pentru utilizare in zone periculoase. Printre acestea compania produce masini de gaurit pneumatice, ideal pentru foraj in zone explozive
- masina de gaurit este perfecta pentru majoritatea lucrarilor de foraj in zone periculoase
- universala
- cu reducerea optima a zgomotului.
- putere: 0.5 kW
- maner ergonomic

Pre Comanda



ZONE 1, 2 GAZ

EGA Master
ART IN INNOVATION

79904	RPM	2100	22566.25
Presiune de lucru	6 bar		
Capacitate mandrina	10 mm		
Capacitate maxima gaurire in otel	10 mm		
Turatie mers in gol	1550 rpm		
Putere motor	0.5 kW		
Consum aer	0.6 m ³ /min		
Racorduri (interior / exterior)	R 1/4" f - R 3/8" f		
Diamentru interior recomandat furtun	≥ 10 mm		
Nivel zgomot	84 dB		
Nivel vibratii	<2,5 m/s ²		
Lungime	235 mm		
Marcaje ATEX	EX II 2G Ex h IIB T6 Gb		
Greutate	2100 kg		

MASTEREX 79249

NOU

Masina de gaurit pneumatica unghiulara cu mandrina MT2

- EGA Master ofera o gama larga de unelte si instrumente intrinsec sigure pentru utilizare in zone periculoase. Printre acestea compania produce masini de gaurit pneumatice, ideal pentru foraj in zone explozive
- masina de gaurit este perfecta pentru majoritatea lucrarilor de foraj in zone periculoase
- universala
- cu reducerea optima a zgomotului.
- putere: 1.33 kW
- maner ergonomic

Pre Comanda



ZONE M2 MINIERE

EGA Master
ART IN INNOVATION

79249	RPM	8500	50860.66
Presiune de lucru	6 bar		
Capacitate mandrina	Madrina MT2		
Capacitate maxima gaurire in otel	23 mm		
Turatie mers in gol	270 rpm		
Putere motor	1.33 kW		
Cuplu maxim	48 Nm		
Consum aer	1.40 m ³ /min		
Racorduri	R 3/4" a		
Diamentru interior recomandat furtun	15 mm		
Nivel zgomot	92 dB		
Nivel vibratii	<3,3 m/s ²		
Marcaje ATEX	EX I M2 c T6		
Greutate	8500 kg		

MASTEREX 79996
NOU
Masina de gaurit pneumatica cu avans pe surub mandrina MT2

- EGA Master ofera o gama larga de unelte si instrumente intrinsec sigure pentru utilizare in zone periculoase. Printre acestea compania produce masini de gaurit pneumatice, ideal pentru foraj in zone explozive
- masina de gaurit este perfecta pentru majoritatea lucrarilor de foraj in zone periculoase

Pre Comanda

ZONE 1, 2 GAZ
EGAMaster
ART IN INNOVATION

79996	RPM	kg	€
79996	250	12000	62999.49
Presiune de lucru	6 bar		
Mandrina	MT2		
Capacitate maxima gaurire in otel	23 mm		
Turatie mers in gol	250 rpm		
Putere motor	1.5 kW		
Cuplu maxim	46 Nm		
Consum aer	1.2 m³/min		
Racorduri	R 3/4" a		
Diamentru interior recomandat furtun	≥ 15 mm		
Marcaje ATEX	EX II 2G c T6		
Greutate	12 kg		

MASTEREX 79633
NOU
Masina de gaurit pneumatica cu talpa magnetica cursa 160 mm

- pentru gaurirea materialului cu suprafata magnetizabila cu carote de pana la 52 mm diametru si burghie pana la 13 mm
- capacitate magnet 800 kg
- comutator cu 3 pozitii: gauriti - magnet - opriti
- cu capac de protectie pentru burghiu care ofera siguranta maxima utilizatorului.

Pre Comanda

ZONE 1, 2 GAZ
EGAMaster
ART IN INNOVATION

79633	RPM	kg	€
79633	250	21500	79789.92
Presiune de lucru	6 bar		
Mandrina	Weldon 19 mm		
Diametru maxim de gaurire	53 mm		
Fora magnetica	800 kg		
Turatie mers in gol	400 rpm		
Putere motor	1.0 kW		
Cursa	160 mm		
Consum aer	1.5 m³/min		
Racorduri	R 3/8" f		
Diamentru interior recomandat furtun	≥ 13 mm		
Marcaje ATEX	EX II 2G c T6		
Greutate	19 kg		

MASTEREX 79330
NOU
Masina de carotat pneumatica capacitate maxima 160 mm, 2.8 kW

- EGA Master ofera o gama larga de unelte si instrumente intrinsec sigure pentru utilizare in zone periculoase. Printre acestea compania produce masini de gaurit pneumatice, ideal pentru foraj in zone explozive
- masina de gaurit este perfecta pentru majoritatea lucrarilor de foraj in zone periculoase

Pre Comanda

ZONE M2 MINIERE
EGAMaster
ART IN INNOVATION

79330	RPM	kg	€
79330	300-700-1350	17700	75316.97
Presiune de lucru	6 bar		
Conexiune carote	1.14"UNC male / R1/2" female		
Trepte cuplu	90/56/29 Nm		
Turatie mers in gol	300-700-1350 rpm		
Putere motor	2.8 kW		
Diametru maxim carote	≤160 mm		
Consum aer	3.5 m³/min		
Racorduri	R 3/4" f		
Diamentru interior recomandat furtun	- mm		
Lungime	660 mm		
Marcaje ATEX	EX I M2 Ex h I Mb T6		
Greutate	17.7 kg		

MASTEREX 79632
NOU
Masina de gaurit pneumatica cu talpa magnetica cursa 125 mm

- pentru gaurirea materialului cu suprafata magnetizabila cu carote de pana la 52 mm diametru si burghie pana la 13 mm
- capacitate magnet 800 kg
- comutator cu 3 pozitii: gauriti - magnet - opriti
- cu capac de protectie pentru burghiu care ofera siguranta maxima utilizatorului.

Pre Comanda

ZONE 1, 2 GAZ
EGAMaster
ART IN INNOVATION

79632	RPM	kg	€
79632	250	19000	78455.28
Presiune de lucru	6 bar		
Mandrina	Weldon 19 mm		
Diametru maxim de gaurire	53 mm		
Fora magnetica	800 kg		
Turatie mers in gol	400 rpm		
Putere motor	1.0 kW		
Cursa	125 mm		
Consum aer	1.5 m³/min		
Racorduri	R 3/8" f		
Diamentru interior recomandat furtun	≥ 13 mm		
Marcaje ATEX	EX II 2G c T6		
Greutate	19 kg		

MASTEREX 79303
NOU
Masina de carotat pneumatica capacitate maxima 160 mm, 1.6 kW

- EGA Master ofera o gama larga de unelte si instrumente intrinsec sigure pentru utilizare in zone periculoase. Printre acestea compania produce masini de gaurit pneumatice, ideal pentru foraj in zone explozive
- masina de gaurit este perfecta pentru majoritatea lucrarilor de foraj in zone periculoase

Pre Comanda

ZONE 1, 2 GAZ
EGAMaster
ART IN INNOVATION

79303	RPM	kg	€
79303	400-900-1600	8200	49778.51
Presiune de lucru	6 bar		
Conexiune carote	1.14"UNC male / R1/2" female		
Trepte cuplu	49/31/16 Nm		
Turatie mers in gol	400-900-1600 rpm		
Putere motor	1.60 kW		
Diametru maxim carote	≤160 mm		
Consum aer	2.2 m³/min		
Racorduri	R 3/4" f		
Diamentru interior recomandat furtun	- mm		
Lungime	550 mm		
Marcaje ATEX	EX II 2G Ex h IIB T6 Gb		
Greutate	8200 kg		

MASTEREX 79422
NOU
Masina de carotat pneumatica capacitate maxima 300 mm, 2.8 kW

- EGA Master ofera o gama larga de unelte si instrumente intrinsec sigure pentru utilizare in zone periculoase. Printre acestea compania produce masini de gaurit pneumatice, ideal pentru foraj in zone explozive
- masina de gaurit este perfecta pentru majoritatea lucrarilor de foraj in zone periculoase

Pre Comanda

ZONE 1, 2 GAZ
EGAMaster
ART IN INNOVATION

79422	RPM	kg	€
79422	300-700-1350	12700	54395.68
Presiune de lucru	6 bar		
Conexiune carote	1.14"UNC male / R1/2" female		
Trepte cuplu	90/56/29 Nm		
Turatie mers in gol	300-700-1350 rpm		
Putere motor	2.8 kW		
Diametru maxim carote	≤300 mm		
Consum aer	3.5 m³/min		
Racorduri	R 3/4" f		
Diamentru interior recomandat furtun	- mm		
Lungime	520 mm		
Marcaje ATEX	EX II 2G Ex h IIB T6 Gb		
Greutate	12.7 kg		

MASTEREX 79613
NOU
Masina pneumatica de insurubat cu impact 1", 1800 Nm

- este esentiala pentru lucrul in zone periculoase precum minierit, lucru in spatii restranse, lucrari subterane etc.
- ideal pentru aplicarea unui cuplu ridicat la toate tipurile de elemente de fixare filetate cu o actiune simpla de declansare
- chiar si elementele de fixare cu niveluri foarte ridicate de rugina pot fi stranse si slabite.

Pre Comanda
EGAMaster
ART IN INNOVATION

ZONE M2 MINIERE

79613	Cuplu	🏠	🔩
1800 Nm	12200		43502.02
Presiune de lucru	6 bar		
Patrat antrenare	1"		
Cuplu maxim	1800 Nm		
Pentru suruburi si piulite	M33 (50 mm AF)		
Racorduri	Rd 32 x 1/8"a		
Diamentru interior recomandat furtun	13 mm		
Nivel zgomot	92 dB		
Nivel vibratii	<3,2 m/s ²		
Lungime	280 mm		
Marcaje ATEX	EX I M2 c T6		
Greutate	9 kg		

MASTEREX 79604
NOU
Masina de gaurit cu pecutie pneumatica 0.5 kW

- perfect pentru gaurirea materialelor groase sau foarte dure precum beton, piatra etc. in medii periculoase
- optiunile de miscare de pecutie si rotatie pot fi aplicate simultan, permitand o performanta mai usoara
- doua functii: gaurire cu ciocan sau gaurire normala
- maner suplimentar reglabil la 360° pentru diferite pozitii
- carcasa metalica robusta pentru o durabilitate mai mare

Pre Comanda
EGAMaster
ART IN INNOVATION

ZONE M2 MINIERE

79604	RPM	🏠	🔩
950	3300		28857.08
Presiune de lucru	6 bar		
Capacitate mandrina	13 mm		
Capacitate maxima gaurire in otel	13 mm		
Turatie mers in gol	950 rpm		
Putere motor	0.500 kW		
Consum de aer	0.6 m ³ /min		
Racorduri	1/4"		
Diamentru interior recomandat furtun	10 mm		
Nivel zgomot	84 dB		
Nivel vibratii	<2,5 m/s ²		
Lungime	290 mm		
Marcaje ATEX	EX I M2 Ex h I Mb T6		
Greutate	3.3 kg		

MASTEREX 79602
NOU
Masina pneumatica de insurubat cu impact 1/2", 610 Nm

- este esentiala pentru lucrul in zone periculoase precum minierit, lucru in spatii restranse, lucrari subterane etc.
- ideal pentru aplicarea unui cuplu ridicat la toate tipurile de elemente de fixare filetate cu o actiune simpla de declansare
- chiar si elementele de fixare cu niveluri foarte ridicate de rugina pot fi stranse si slabite.

Pre Comanda
EGAMaster
ART IN INNOVATION

ZONE M2 MINIERE

79602	Cuplu	🏠	🔩
610 Nm	3600		20127.86
Presiune de lucru	6 bar		
Patrat antrenare	1/2"		
Cuplu maxim	610 Nm		
Pentru suruburi si piulite	M20 (30 mm AF)		
Racorduri	1/4"		
Diamentru interior recomandat furtun	10 mm		
Nivel zgomot	90 dB		
Nivel vibratii	<2,6 m/s ²		
Lungime	160 mm		
Marcaje ATEX	EX IM2cT6		
Greutate	3.6 kg		

MASTEREX 79626
NOU
Masina pneumatica de insurubat cu impact 3/4", 1350 Nm

- este esentiala pentru lucrul in zone periculoase precum minierit, lucru in spatii restranse, lucrari subterane etc.
- ideal pentru aplicarea unui cuplu ridicat la toate tipurile de elemente de fixare filetate cu o actiune simpla de declansare
- chiar si elementele de fixare cu niveluri foarte ridicate de rugina pot fi stranse si slabite.

Pre Comanda
EGAMaster
ART IN INNOVATION

ZONE 1, 2 GAZ

79626	Cuplu	🏠	🔩
1350 Nm	5600		38957.17
Presiune de lucru	6 bar		
Patrat antrenare	3/4"		
Cuplu maxim	1350 Nm		
Pentru suruburi si piulite	M30 (46 mm AF)		
Racorduri	1/4"		
Diamentru interior recomandat furtun	13 mm		
Nivel zgomot	96 dB		
Nivel vibratii	<4,5 m/s ²		
Lungime	220 mm		
Marcaje ATEX	EX II 2G Ex h IIB T6 Gb		
Greutate	5.6 kg		

MASTEREX 79631
NOU
Masina pneumatica de insurubat cu impact 1.1/2", 4400 Nm

- este esentiala pentru lucrul in zone periculoase precum minierit, lucru in spatii restranse, lucrari subterane etc.
- ideal pentru aplicarea unui cuplu ridicat la toate tipurile de elemente de fixare filetate cu o actiune simpla de declansare
- chiar si elementele de fixare cu niveluri foarte ridicate de rugina pot fi stranse si slabite.

Pre Comanda
EGAMaster
ART IN INNOVATION

ZONE 1, 2 GAZ

79631	Cuplu	🏠	🔩
4400 Nm	12200		66948.37
Presiune de lucru	6 bar		
Patrat antrenare	1.1/2"		
Cuplu maxim	4400 Nm		
Pentru suruburi si piulite	M56 (85 mm AF)		
Racorduri	1/2"		
Diamentru interior recomandat furtun	15 mm		
Nivel zgomot	107 dB		
Nivel vibratii	<6,6 m/s ²		
Lungime	- mm		
Marcaje ATEX	EX II 2G c T6		
Greutate	12.2 kg		

MASTEREX 79625
NOU
Masina pneumatica de insurubat cu impact 1", 2200 Nm

- este esentiala pentru lucrul in zone periculoase precum minierit, lucru in spatii restranse, lucrari subterane etc.
- ideal pentru aplicarea unui cuplu ridicat la toate tipurile de elemente de fixare filetate cu o actiune simpla de declansare
- chiar si elementele de fixare cu niveluri foarte ridicate de rugina pot fi stranse si slabite.

Pre Comanda
EGAMaster
ART IN INNOVATION

ZONE 1, 2 GAZ

79625	Cuplu	🏠	🔩
2200 Nm	11000		61718.08
Presiune de lucru	6 bar		
Patrat antrenare	1"		
Cuplu maxim	2200 Nm		
Pentru suruburi si piulite	M36 (54 mm AF)		
Racorduri	1/2"		
Diamentru interior recomandat furtun	13 mm		
Nivel zgomot	92 dB		
Nivel vibratii	<6,2 m/s ²		
Lungime	- mm		
Marcaje ATEX	EX II 2G Ex h IIB T6 Gb		
Greutate	11 kg		



MASTEREX 76739
NOU
Masina pneumatica de insurubat cu impact 3/4", 1350 Nm

- este esentiala pentru lucrul in zone periculoase precum minerit, lucru in spatii restranse, lucrari subterane etc.
- ideal pentru aplicarea unui cuplu ridicat la toate tipurile de elemente de fixare filetate cu o actiune simpla de declansare
- chiar si elementele de fixare cu niveluri foarte ridicate de rugina pot fi stranse si slabite.



ZONE M2 MINIERE

 EGA Master
ART IN INNOVATION

Pre Comanda

Barcode	Cuplu	g	9000
76739	1350 Nm	6400	48047.02
	Presiune de lucru	6 bar	
	Patrat antrenare	3/4"	
	Cuplu maxim	1350 Nm	
	Pentru suruburi si piulite	M30 (46 mm AF)	
	Racorduri	R 1/4" f	
	Diamentru interior recomandat furtun	13 mm	
	Nivel zgomot	96 dB	
	Nivel vibratii	<4,5 m/s ²	
	Lungime	280 mm	
	Marcaje ATEX	EX I M2 c T6	
	Greutate	6.4 kg	

MASTEREX 79725
NOU
Masina pneumatica de insurubat cu impact 3/4", 1350 Nm

- este esentiala pentru lucrul in zone periculoase precum minerit, lucru in spatii restranse, lucrari subterane etc.
- ideal pentru aplicarea unui cuplu ridicat la toate tipurile de elemente de fixare filetate cu o actiune simpla de declansare
- chiar si elementele de fixare cu niveluri foarte ridicate de rugina pot fi stranse si slabite.



ZONE 1, 2 GAZ

 EGA Master
ART IN INNOVATION

Pre Comanda

Barcode	Cuplu	g	9000
79725	610 Nm	2500	9306.39
	Presiune de lucru	6 bar	
	Patrat antrenare	1/2"	
	Cuplu maxim	610 Nm	
	Pentru suruburi si piulite	M20 (30 mm AF)	
	Racorduri	R 1/4" f	
	Diamentru interior recomandat furtun	10 mm	
	Nivel zgomot	90 dB	
	Nivel vibratii	<2,6 m/s ²	
	Lungime	- mm	
	Marcaje ATEX	EX II 2G Ex h IIB T6 Gb	
	Greutate	2.5 kg	

MASTEREX 79607 1"
NOU
Cheie dinamometrica pneumatica 1" 4 bar: 650 Nm / 6 bar: 750 Nm

- cheile dinamometrice EGA Master ATEX sunt folosite pentru a regla cuplul elementelor filetate
- au un mecanism care evita transferul unui cuplu suplimentar dupa atingerea valorii dorite a cuplului.



ZONE M2 MINIERE

 EGA Master
ART IN INNOVATION

Barcode	Cuplu	g	9000
76739	650 / 750 Nm	7800	87491.06
	Presiune de lucru	4/6 bar	
	Patrat antrenare	1"	
	Acuratete	±5-10%	
	Cuplu	4 bar: 650 Nm / 6 bar: 750 Nm	
	Consum aer	4 bar: 0,55 m ³ /min / 6 bar: 0,75 m ³ /min	
	Pentru suruburi si piulite	M30 (46 mm AF)	
	Reversibila	da	
	Racorduri	Rd 32 x 1/8"	
	Diamentru interior furtun	10 mm	
	Nivel zgomot	86.4 dB	
	Nivel vibratii	<2,5 m/s ²	
	Marcaje ATEX	EX I M2 c T6	
	Greutate	7,8 kg	

MASTEREX 79608 1"
NOU
Cheie dinamometrica pneumatica 1" 4 bar: 1500 Nm / 6 bar: 1800 Nm

- cheile dinamometrice EGA Master ATEX sunt folosite pentru a regla cuplul elementelor filetate
- au un mecanism care evita transferul unui cuplu suplimentar dupa atingerea valorii dorite a cuplului.



ZONE M2 MINIERE

 EGA Master
ART IN INNOVATION

Barcode	Cuplu	g	9000
79608	1500 / 1800 Nm	8600	88677.85
	Presiune de lucru	4/6 bar	
	Patrat antrenare	1"	
	Acuratete	±5-10%	
	Cuplu	4 bar: 1500 Nm / 6 bar: 1800 Nm	
	Consum aer	4 bar: 0,55 m ³ /min / 6 bar: 0,65 m ³ /min	
	Pentru suruburi si piulite	M30 (46 mm AF)	
	Reversibila	da	
	Racorduri	Rd 32 x 1/8"	
	Diamentru interior furtun	10 mm	
	Nivel zgomot	86.4 dB	
	Nivel vibratii	<2,5 m/s ²	
	Marcaje ATEX	EX I M2 c T6	
	Greutate	8,6 kg	

MASTEREX 79609 1.1/2"
NOU
Cheie dinamometrica pneumatica 1" 4 bar: 2800 Nm / 6 bar: 3600 Nm

- cheile dinamometrice EGA Master ATEX sunt folosite pentru a regla cuplul elementelor filetate
- au un mecanism care evita transferul unui cuplu suplimentar dupa atingerea valorii dorite a cuplului.

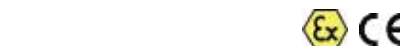

ZONE M2 MINIERE

 EGA Master
ART IN INNOVATION

Barcode	Cuplu	g	9000
79609	2800 / 3600 Nm	14900	125076.39
	Presiune de lucru	4/6 bar	
	Patrat antrenare	1.1/2"	
	Acuratete	±5-10%	
	Cuplu	4 bar: 2800 Nm / 6 bar: 3600 Nm	
	Consum aer	4 bar: 1,30 m ³ /min / 6 bar: 1,70 m ³ /min	
	Pentru suruburi si piulite	M48 (75 mm AF)	
	Reversibila	da	
	Racorduri	Rd 32 x 1/8"	
	Diamentru interior furtun	10 mm	
	Nivel zgomot	93 dB	
	Nivel vibratii	<2,5 m/s ²	
	Marcaje ATEX	EX I M2 c T6	
	Greutate	14,9 kg	

MASTEREX 79616
NOU
Fierastrau pneumatic cu banda 1 kW

- proiectat pentru aplicatii miniere generale, este ideal pentru cea mai grea utilizare in lucrari subterane, maritime, demolari in mare liber etc.
- in medii umede nu prezinta risc de soc electric sau scurtcircuit.
- este mai sigur de utilizat decat fierastrau electric in atmosfere cu risc de explozie
- are o capacitate de taiere de pana la 7"
- carcasa din otel inoxidabil



ZONE M2 MINIERE

 EGA Master
ART IN INNOVATION

Barcode	Putere	g	9000
79616	1 kW	13000	71132.74
	Presiune de lucru	6 bar	
	Capacitate taiere	Ø180 mm/AxB=180x180 mm/AxB=7x7"	
	Putere	1 kW	
	Material carcasa	INOX	
	Consum aer	1,2 m ³ /min	
	Racorduri	R 1/2" i	
	Diamentru interior furtun	13 mm	
	Nivel zgomot	81,7 dB	
	Nivel vibratii	<2,5 m/s ²	
	Dimensiuni	730 x 285 x 290 mm	
	Marcaje ATEX	EX I M2 c T6	
	Greutate	13 kg	

MASTEREX 79658
NOU
Fierastrau pneumatic cu banda 0.5 kW

- proiectat pentru aplicatii miniere generale, este ideal pentru cea mai grea utilizare in lucrari subterane, maritime, demolari in mare liber etc.
- in medii umede nu prezinta risc de soc electric sau scurtcircuit.
- este mai sigur de utilizat decat fierastraul electric in atmosfere cu risc de explozie
- are o capacitate de taiere de pana la 7"
- carcasa din aluminiu

Pre Comanda

EGAMaster
ART IN INNOVATION

ZONE 1, 2 GAZ

Putere	Pondere	Preț
0.5 kW	19000	35927.13
Presiune de lucru	6 bar	
Capacitate taiere	ø80 mm/AxB=80x100 mm/AxB=3"x4"	
Putere	0.5 kW	
Material carcasa	Aluminiu	
Consum aer	0.5 m³/min	
Racorduri	R 1/4"	
Diamentru interior furtun	7 mm	
Nivel zgomot	87.0 dB	
Nivel vibratii	<2,5 m/s²	
Dimensiuni	640 x 390 x 315 mm	
Marcaje ATEX	EX II 2G Ex h IIB T6 Gb	
Greutate	19 kg	

MASTEREX 79618
NOU
Fierastrau portabil pneumatic 1.1 kW

- este conceput pentru cele mai dificile aplicatii in rafinarii, centrale electrice, constructii, aplicarii de demolare, industria petrolului
- o solutie ideala pentru taierea in spatii restranse
- tip supapa TWIST2
- dimensiune compacta ideala pentru taierea in spatii inguste
- este potrivit pentru foi de pana la 37" lungime

Pre Comanda

ZONE M2 MINIERE
EGAMaster
ART IN INNOVATION

Putere	Pondere	Preț
1.1 kW	7500	62293.43
Presiune de lucru	6 bar	
Cursa	60 mm	
Numar de curse	330 curse / minut	
Putere	1.1 kW	
Tip supapa	TWIST2	
Consum aer	1.45 m³/min	
Racorduri	R 3/4" a	
Diamentru interior furtun	13 mm	
Nivel zgomot	84.0 dB	
Nivel vibratii	<2,5 m/s²	
Material carcasa	Zamak	
Marcaje ATEX	EX I M2 Ex h I Mb T5	
Greutate	7,5 kg	

MASTEREX 79816
NOU
Fierastrau sabie pneumatic 1.0 kW

- este conceput pentru cele mai dificile aplicatii in rafinarii, centrale electrice, constructii, aplicarii de demolare, industria petrolului
- o solutie ideala pentru taierea in spatii restranse
- dimensiune compacta ideala pentru taierea in spatii inguste

Pre Comanda

ZONE M2 MINIERE
EGAMaster
ART IN INNOVATION

Putere	Pondere	Preț
1.0 kW	7000	37875.02
Presiune de lucru	6 bar	
Cursa	28 mm	
Numar de curse	1200 curse / minut	
Putere	1.0 kW	
Capacitate taiere lemn	160 mm	
Capacitate taiere otel	19 mm	
Consum aer	1.3 m³/min	
Nivel zgomot	81-92 dB	
Nivel vibratii	<2,5 m/s²	
Marcaje ATEX	EX I M2 Ex h I Mb T5	
Greutate	7 kg	

MASTEREX 79617
NOU
Fierastrau portabil pneumatic 1.1 kW

- este conceput pentru cele mai dificile aplicatii in rafinarii, centrale electrice, constructii, aplicarii de demolare, industria petrolului
- o solutie ideala pentru taierea in spatii restranse
- tip supapa TWIST2
- dimensiune compacta ideala pentru taierea in spatii inguste
- este potrivit pentru foi de pana la 37" lungime

Pre Comanda

ZONE 1, 2 GAZ
EGAMaster
ART IN INNOVATION

Putere	Pondere	Preț
1.1 kW	6400	40688.52
Presiune de lucru	6 bar	
Cursa	60 mm	
Numar de curse	330 curse / minut	
Putere	1.1 kW	
Tip supapa	TWIST2	
Consum aer	1.45 m³/min	
Racorduri	R 3/4" a	
Diamentru interior furtun	13 mm	
Nivel zgomot	84.0 dB	
Nivel vibratii	<2,5 m/s²	
Material carcasa	Aluminiu	
Marcaje ATEX	EX II2GcT5	
Greutate	6,4 kg	

MASTEREX 36809
NOU
Fierastrau sabie pneumatic 1.25 kW

- este conceput pentru cele mai dificile aplicatii in rafinarii, centrale electrice, constructii, aplicarii de demolare, industria petrolului
- o solutie ideala pentru taierea in spatii restranse
- dimensiune compacta ideala pentru taierea in spatii inguste

Pre Comanda

ZONE 1, 2 GAZ
EGAMaster
ART IN INNOVATION

Putere	Pondere	Preț
1.25 kW	4000	27933.79
Presiune de lucru	6 bar	
Cursa	28 mm	
Numar de curse	2300 curse / minut	
Putere	1.25 kW	
Capacitate taiere lemn	160 mm	
Capacitate taiere otel	19 mm	
Consum aer	1.45 m³/min	
Nivel zgomot	101-102 dB	
Nivel vibratii	<2,5 m/s²	
Marcaje ATEX	EX II 2G Ex h IIB T5 Gb	
Greutate	4 kg	

MASTEREX 79836
NOU
Fierastrau circular pneumatic 1.8 kW

- este conceput pentru cele mai dificile aplicatii in rafinarii, centrale electrice, constructii, aplicarii de demolare, industria petrolului
- o solutie ideala pentru taierea in spatii restranse
- dimensiune compacta ideala pentru taierea in spatii inguste

Pre Comanda

ZONE: 2 GAZ
EGAMaster
ART IN INNOVATION

Putere	Pondere	Preț
1.8 kW	11000	61090.48
Presiune de lucru	6 bar	
Capacitate	120 mm	
Dimensiuni panza circular	≤ 320 mm	
Putere	1.8 kW	
Consum aer	2 m³/min	
Racord	R 1/2"	
Nivel zgomot	95 dB	
Nivel vibratii	<2,5 m/s²	
Marcaje ATEX	EX II 3G Ex h IIB T5 Gc	
Greutate	11 kg	

MASTEREX 79989
NOU
Fierastrau circular pneumatic 1.3 kW

- este conceput pentru cele mai dificile aplicatii in rafinarii, centrale electrice, constructii, aplicarii de demolare, industria petrolului
- o solutie ideala pentru taierea in spatii restranse
- dimensiune compacta ideala pentru taierea in spatii inguste

Pre Comanda

EGAMaster
ART IN INNOVATION

ZONE: 1, 2 GAZ

Putere	Greutate	Numar articole	Pret
1.3 kW	6500	34303.91	
Presiune de lucru	6 bar		
Capacitate	65 mm (90°) - 40 mm (45°)		
Dimensiuni panza circular	≤ 190 mm		
Putere	1.3 kW		
Consum aer	1.5 m³/min		
Racord	R 1/2"		
Nivel zgomot	95,4 dB		
Nivel vibratii	<2.5 m/s²		
Marcaje ATEX	EX II 2G Ex h IIB T5 Gc		
Greutate	6,5 kg		

MASTEREX 79620
NOU
Ventilator pneumatic axial

- ideal pentru ventilatie, rezervoare de deseuri ale navelor, depozite uleiuri, precum si lucrari interioare sau subterane etc.
- echipat cu priză cu impamantare
- protectie din aluminiu.
- fabricat din materiale care nu produc scantei si neferoase
- maner ergonomic pentru un transport usor.

Pre Comanda

ZONE: 1, 2 GAZ

EGAMaster
ART IN INNOVATION

Debit aer	Greutate	Numar articole	Pret
0,57 m³/s	13000	26548.43	
Presiune de lucru	5 bar		
Diametru nominal	300 mm		
Lungime	350 mm		
Inaltime	450 mm		
Latime	450 mm		
Consum aer	1.48 m³/min		
Nivel zgomot	85 dB		
Flux aer iesire	0.57 m³/s		
Marcaje ATEX	EX II2GcT6		
Greutate	13 kg		

MASTEREX 72984
NOU
Ventilator pneumatic axial

- ideal pentru ventilatie, rezervoare de deseuri ale navelor, depozite uleiuri, precum si lucrari interioare sau subterane etc.
- echipat cu priză cu impamantare
- protectie din aluminiu.
- fabricat din materiale care nu produc scantei si neferoase

Pre Comanda

ZONE: 1, 2 GAZ

EGAMaster
ART IN INNOVATION

Debit aer	Greutate	Numar articole	Pret
14,9-20,5m³/s	3300	12120.02	
Presiune de lucru	2-6 bar		
Diametru nominal	100 mm		
Lungime	410 mm		
Cuplaj	G 3/8" f		
Consum aer	1,6-2,3 m³/min		
Nivel zgomot	100,8 dB		
Flux aer iesire	14,9 (4 bar) / 17,7 (5 bar) / 20,5 (6 bar) m³/min		
Marcaje ATEX	EX II 2G c T6		
Greutate	3,3 kg		

MASTEREX 79199
NOU
Fierastrau circular pneumatic 1.5 kW

- este conceput pentru cele mai dificile aplicatii in rafinarii, centrale electrice, constructii, aplicarii de demolare, industria petrolului
- o solutie ideala pentru taierea in spatii restranse
- dimensiune compacta ideala pentru taierea in spatii inguste

Pre Comanda

ZONE: 1, 2 GAZ

EGAMaster
ART IN INNOVATION

Putere	Greutate	Numar articole	Pret
1.5 kW	8600	39389.84	
Presiune de lucru	6 bar		
Capacitate	84 mm (90°) - 56 mm (45°)		
Dimensiuni panza circular	≤ 230 mm		
Putere	1.5 kW		
Consum aer	2 m³/min		
Racord	R 1/2"		
Nivel zgomot	103,3 dB		
Nivel vibratii	<2.5 m/s²		
Marcaje ATEX	EX II 2G Ex h IIB T5 Gc		
Greutate	8,6 kg		

MASTEREX 79000
NOU
Ventilator pneumatic axial

- ideal pentru ventilatie, rezervoare de deseuri ale navelor, depozite uleiuri, precum si lucrari interioare sau subterane etc.
- echipat cu priză cu impamantare
- protectie din aluminiu.
- fabricat din materiale care nu produc scantei si neferoase

Pre Comanda

ZONE: 1, 2 GAZ

EGAMaster
ART IN INNOVATION

Debit aer	Greutate	Numar articole	Pret
3.15 m³/s	32000	71341.89	
Presiune de lucru	4 bar		
Diametru nominal	400 mm		
Lungime	440 mm		
Cuplaj	cuplaj cu gheara mama 3/4"		
Consum aer	2.03 m³/min		
Nivel zgomot	92 dB		
Flux aer iesire	3.15 m³/s		
Marcaje ATEX	EX II 2G c IIB T6		
Greutate	32 kg		

MASTEREX 72994
NOU
Ventilator pneumatic axial

- ideal pentru ventilatie, rezervoare de deseuri ale navelor, depozite uleiuri, precum si lucrari interioare sau subterane etc.
- echipat cu priză cu impamantare
- protectie din aluminiu.
- fabricat din materiale care nu produc scantei si neferoase

Pre Comanda

ZONE: M2 MINIERA

EGAMaster
ART IN INNOVATION

Debit aer	Greutate	Numar articole	Pret
14,9-20,5m³/s	3300	19478.52	
Presiune de lucru	2-6 bar		
Diametru nominal	101,6 mm		
Lungime	410 mm		
Cuplaj	G 1/2" f		
Consum aer	1,6-2,3 m³/min		
Nivel zgomot	100,8 dB		
Flux aer iesire	14,9 (4 bar) / 17,7 (5 bar) / 20,5 (6 bar) m³/min		
Marcaje ATEX	EX I M2 c T6		
Greutate	4,8 kg		

EGA Master a lansat o gama foarte completa de scule pneumatice si hidraulice pentru aplicatii subacvatice; polizoare, masini de insurubat cu impact, masini de gaurit, fierastrae (etc.). Toate sunt special concepute pentru profesionistii care lucreaza de obicei in mediul subacvatic: barci scufundate, structuri scufundate, platforme petroliere, centrale hidroelectrice (etc.). Datorita designului lor, sunt potrivite pentru a fi utilizate la toate adancimile accesibile scafandrilor.



INAINTE DE FUNCTIONAREA SUBACVATICA

- Testati masina pentru scurgeri.
- Testati toate functiile masinii.
- Pulverizati toate piesele in miscare cu lubrifiant OKS 8601 (sau similar).

DUPA OPERATIUNARE SUBACVATICA

- Curatati masina.
- Uscati masina cu aer comprimat.
- Pulverizati toate piesele in miscare cu lubrifiant OKS 8601 (sau similar).



79900

NOU

Polizor pneumatic pentru mediu subacvatic 11600 rpm

- EGA Master ofera o gama larga de unelte pentru lucrari subacvatice, cum ar fi polizorul unghiular pneumatic
- un instrument versatil folosit in industria metalica si a constructiilor pentru a lucra cu diferite materiale (otel, beton, piatra, lemn etc.) in medii subacvatice.
- ideal pentru cele mai solicitante aplicatii de slefuire sau lustruire in lucrarile de intretinere si inspectie subacvatice
- in functie de instrumentul de insertie ales, se pot face diverse lucrari precum slefuirea, polizarea, debavurarea, taierea, decuparea, indepartarea ruginii etc.
- puternic si usor

Pre Comanda



CE
EGA Master
ART IN INNOVATION
AQUAMaster

79900	RPM	⚙️	💰
11600	2500		27702.75
Presiune de lucru	6,0 bar		
Racord aer	1/4"		
Nivel vibratii	< 2.5m/s ²		
Nivel de zgomot	85,7 dBA		
Consum aer	1 m ³ /min		
Disc abraziv	≤ 125 mm		
Turatie mers in gol	11600 rpm		
Putere	0,90 kW		
Diametru furtun aer comprimat	≥ 10 mm		
Greutate	2,5 kg		



79901

NOU

Polizor pneumatic drept pentru mediu subacvatic 11600 rpm

- EGA Master ofera o gama larga de unelte pentru lucrari subacvatice, cum ar fi polizorul drept pneumatic
- un instrument versatil folosit in industria metalica si a constructiilor pentru a lucra cu diferite materiale (otel, beton, piatra, lemn etc.) in medii subacvatice.
- ideal pentru cele mai solicitante aplicatii de slefuire sau lustruire in lucrarile de intretinere si inspectie subacvatice
- in functie de instrumentul de insertie ales, se pot face diverse lucrari precum slefuirea, polizarea, debavurarea, taierea, decuparea, indepartarea ruginii etc.
- puternic si usor

Pre Comanda



CE
EGA Master
ART IN INNOVATION
AQUAMaster

79901	RPM	⚙️	💰
20000	1400		20777.07
Presiune de lucru	6,0 bar		
Racord aer	1/4"		
Nivel vibratii	< 2.5m/s ²		
Nivel de zgomot	85,9 dBA		
Consum aer	0,85 m ³ /min		
Penseta	6 mm		
Turatie mers in gol	20000 rpm		
Putere	0,70 kW		
Diametru furtun aer comprimat	≥ 10 mm		
Lungime	250 mm		
Greutate	1,4 kg		

MASTEREX 79902

NOU

Masina pneumatica de insurubat cu impact 3/4", 1350 Nm

- este esentiala pentru lucrul in zone periculoase precum minerit, lucru in spatii restranse, lucrari subterane etc.
- ideal pentru aplicarea unui cuplu ridicat la toate tipurile de elemente de fixare filetate cu o actiune simpla de declansare
- chiar si elementele de fixare cu niveluri foarte ridicate de rugina pot fi stranse si slabite.



Pre Comanda

CE
EGA Master
ART IN INNOVATION
AQUAMaster



ZONE 1, 2 GAZ

79902	Cuplu	⚙️	💰
1350 Nm	5600		41770.67
Presiune de lucru	6 bar		
Patrat antrenare	3/4"		
Cuplu maxim	1350 Nm		
Pentru suruburi si piulite	M30 (46 mm AF)		
Racorduri	1/4"		
Diametru interior recomandat furtun	13 mm		
Nivel zgomot	96 dB		
Nivel vibratii	< 4,5 m/s ²		
Lungime	220 mm		
Marcaje ATEX	EX II 2G Ex h IIB T6 Gb		
Greutate	5,6 kg		



MASTEREX 79904

NOU

Masina de gaurit pneumatica mandrina max. 13 mm

- EGA Master ofera o gama larga de unelte si instrumente intrinsec sigure pentru utilizare in zone periculoase. Printre acestea compania produce masini de gaurit pneumatice, ideal pentru foraj in zone explozive
- masina de gaurit este perfecta pentru majoritatea lucrarilor de foraj in zone periculoase
- universala
- cu reducerea optima a zgomotului.
- putere: 0.5 kW
- maner ergonomic

Pre Comanda



ZONE 1, 2 GAZ

EGA Master
ART IN INNOVATION
AQUAMaster

79904	RPM	⚙️	💰
1550	2100		22566.25
Presiune de lucru	6 bar		
Capacitate mandrina	10 mm		
Capacitate maxima gaurire in otel	10 mm		
Turatie mers in gol	1550 rpm		
Putere motor	0,5 kW		
Consum aer	0,6 m ³ /min		
Racorduri (interior / exterior)	R 1/4" f - R 3/8" f		
Diametru interior recomandat furtun	≥ 10 mm		
Nivel zgomot	84 dB		
Nivel vibratii	< 2,5 m/s ²		
Lungime	235 mm		
Marcaje ATEX	EX II 2G Ex h IIB T6 Gb		
Greutate	2100 kg		



MASTEREX 79606

NOU

Masina de gaurit cu pecutie pneumatica 0.5 kW

- perfect pentru gaurirea materialelor groase sau foarte dure precum beton, piatra etc. in medii periculoase
- optiunile de miscare de pecutie si rotatie pot fi aplicate simultan, permitand o performanta mai usoara
- doua functii: gaurire cu ciocan sau gaurire normala
- maner suplimentar reglabil la 360° pentru diferite pozitii
- carcasa metalica robusta pentru o durabilitate mai mare

Pre Comanda



CE
EGA Master
ART IN INNOVATION
AQUA Master



ZONE 1, 2 GAZ

79606	RPM	3300	52808.55
Presiune de lucru	6 bar		
Capacitate mandrina	13 mm		
Capacitate maxima gaurire in otel	13 mm		
Capacitate maxima gaurire in beton	20 mm		
Turatie mers in gol	950 rpm		
Putere motor	0.500 kW		
Consum de aer	0.6 m³/min		
Racorduri (interior / exterior)	R 1/4" f - R 3/8" f		
Diamentru interior recomandat furtun	10 mm		
Nivel zgomot	84 dB		
Nivel vibratii	<2,5 m/s²		
Lungime	300 mm		
Marcaje ATEX	EX II 2G Ex h IIB T6 Gb		
Greutate	3.3 kg		



MASTEREX 79607

NOU

Masina de gaurit cu pecutie, SDS-plus pneumatica 0.5 kW

- esentiala pentru gaurirea materialelor precum beton, caramida, piatra
- rotirea este insotita de o miscare de pecutie care provoaca ruperea materialului si permite avansarea burghiei facilitand realizarea gaurii
- echipat cu un ambreiaj de siguranta care protejeaza impotriva supraincercarilor si blocajelor
- un maner lateral reglabil si un indicator de adancime ofera un confort sport.

Pre Comanda



CE
EGA Master
ART IN INNOVATION
AQUA Master



ZONE 1, 2 GAZ

79907	RPM	625	6300	87491.06
Presiune de lucru	6 bar			
Port-scula	SDS-max			
Pecutie	3000 imp			
Capacitate maxima gaurire in beton	28 mm			
Turatie mers in gol	625 rpm			
Putere motor	0.500 kW			
Consum de aer	0.6 m³/min			
Racorduri (interior / exterior)	R 1/2" f / R 3/8" f			
Nivel zgomot	93 dB			
Nivel vibratii	<4,2 m/s²			
Diamentru interior recomandat furtun	≥ 13 mm			
Lungime	400 mm			
Marcaje ATEX	EX II 2G Ex h IIB T6 Gb			
Greutate	6.3 kg			

MASTEREX 79608

NOU

Masina de gaurit cu pecutie, SDS-max pneumatica 0.5 kW

- esentiala pentru gaurirea materialelor precum beton, caramida, piatra
- rotirea este insotita de o miscare de pecutie care provoaca ruperea materialului si permite avansarea burghiei facilitand realizarea gaurii
- echipat cu un ambreiaj de siguranta care protejeaza impotriva supraincercarilor si blocajelor
- un maner lateral reglabil si un indicator de adancime ofera un confort sport.

Pre Comanda



CE
EGA Master
ART IN INNOVATION
AQUA Master



ZONE 1, 2 GAZ

79908	RPM	250	3300	88677.85
Presiune de lucru	6 bar			
Port-scula	SDS-max			
Pecutie	2500 imp			
Capacitate maxima gaurire in zidarie	80 mm			
Capacitate maxima gaurire in beton	50 mm			
Turatie mers in gol	250 rpm			
Putere motor	1.500 kW			
Consum de aer	1.5 m³/min			
Racorduri (interior / exterior)	R 1/2" f / R 3/8" f			
Nivel zgomot	90.4 dB			
Nivel vibratii	<9.2 m/s²			
Diamentru interior recomandat furtun	≥ 13 mm			
Lungime	640 mm			
Marcaje ATEX	EX II 2G Ex h IIB T6 Gb			
Greutate	13.3 kg			



MASTEREX 79357

NOU

Masina de carotat pneumatica capacitate maxima 160 mm, 1.6 kW

- EGA Master ofera o gama larga de unelte si instrumente intrinsec sigure pentru utilizare in zone periculoase. Printre acestea compania produce masini de gaurit pneumatice, ideal pentru foraj in zone explozive
- masina de gaurit este perfecta pentru majoritatea lucrarilor de foraj in zone periculoase

Pre Comanda



CE
EGA Master
ART IN INNOVATION
AQUA Master



ZONE 1, 2 GAZ

79357	RPM	400-900-1600	8200	52375.47
Presiune de lucru	6 bar			
Conexiune carote	1.1/4" UNC male / R1/2" female			
Trepte cuplu	49/31/16 Nm			
Turatie mers in gol	400-900-1600 rpm			
Putere motor	1.60 kW			
Diamentru maxim carote	≤160 mm			
Consum aer	2.2 m³/min			
Racorduri	R 3/4" f			
Diamentru interior recomandat furtun	- mm			
Lungime	550 mm			
Marcaje ATEX	EX II 2G Ex h IIB T6 Gb			
Greutate	8200 kg			



79921

NOU

Polizor hidraulic pentru mediu subacvatic 3600 rpm

- EGA Master ofera o gama larga de unelte pentru lucrari subacvatice, cum ar fi polizorul unghiular hidraulic
- un instrument versatil folosit in industria metalica si a constructiilor pentru a lucra cu diferite materiale (otel, beton, piatra, lemn etc.) in medii subacvatice.
- ideal pentru cele mai solicitante aplicatii de dslefuire sau lustruire in lucrarile de intretinere si inspectie subacvatice
- in functie de instrumentul de insertie ales, se pot face diverse lucrari precum slefuirea, polizarea, debavurarea, taierea, decuparea, indepartarea ruginii etc.
- puternic si usor



Pre Comanda

CE
EGA Master
ART IN INNOVATION
AQUA Master

79921	RPM	5800	40905.07
Presiune de lucru	90-140 bar		
Disc abraziv	≤ 230 mm		
Filat disc	22.2/5/8-11UNC		
Turatie mers in gol	3600 rpm		
Putere	3,5 kW		
Debit ulei	20-45 l/min		
Racord	3/4"-16UNF		
Greutate	5,8 kg		



79909

NOU

Polizor hidraulic drept pentru mediu subacvatic 10400 rpm

- EGA Master ofera o gama larga de unelte pentru lucrari subacvatice, cum ar fi polizorul unghiular hidraulic
- un instrument versatil folosit in industria metalica si a constructiilor pentru a lucra cu diferite materiale (otel, beton, piatra, lemn etc.) in medii subacvatice.
- ideal pentru cele mai solicitante aplicatii de slefuire sau lustruire in lucrarile de intretinere si inspectie subacvatice
- in functie de instrumentul de insertie ales, se pot face diverse lucrari precum slefuirea, polizarea, debavurarea, taierea, decuparea, indepartarea ruginii etc.



CE
EGA Master
ART IN INNOVATION
AQUA Master

Pre Comanda

79909	RPM	5800	29867.19
Presiune de lucru	105 bar		
Penseta	6 mm		
Filet montaj	1/4"		
Turatie mers in gol	10400 rpm		
Putere	1,1 kW		
Debit ulei	7,5 l/min		
Racord	R 1/2"FF		
Nivel zgomot	90,70 db		
Nivel vibratii	<2,5 m/s ²		
Lungime	270 mm		
Greutate	1,6 kg		

79911

NOU

Polizor hidraulic drept pentru mediu subacvatic 7000 rpm

- EGA Master ofera o gama larga de unelte pentru lucrari subacvatice, cum ar fi polizorul unghiular hidraulic
- un instrument versatil folosit in industria metalica si a constructiilor pentru a lucra cu diferite materiale (otel, beton, piatra, lemn etc.) in medii subacvatice.
- ideal pentru cele mai solicitante aplicatii de dslefuire sau lustruire in lucrarile de intretinere si inspectie subacvatice
- in functie de instrumentul de insertie ales, se pot face diverse lucrari precum slefuirea, polizarea, debavurarea, taierea, decuparea, indepartarea ruginii etc.
- puternic si usor



Pre Comanda

CE
EGA Master
ART IN INNOVATION
AQUA Master

79911	RPM	7600	51509.86
Presiune de lucru	140 bar		
Disc	≤ 200 mm		
Turatie mers in gol	7000 rpm		
Putere	1,8 kW		
Debit ulei	18-50 l/min		
Racord	1/2"FF		
Nivel zgomot	80,60 db		
Nivel vibratii	<2,5 m/s ²		
Greutate	7,6 kg		

79917

NOU

Masina de insurubat hidraulica pentru mediu subacvatic 3/4" 1700 Nm

- cheile hidraulice de impact EGA Master sunt instrumentele ideale pentru operatiuni subacvatice si operatiuni in atmosfere explozive: intretinere, reparatii si constructie
- esential pentru lucrarile de imersie, cum ar fi repararea si inspectia navelor, lucrarile de constructie si intretinere subacvatice
- esential pentru a lucra in zone periculoase precum industria petrolului, rafinarii, uzine chimice, minerit, lucrari subterane... etc.
- acesta este un instrument ideal pentru aplicarea cuplurilor mari la orice tip de surub datorita actiunii simple de declansare
- permite strangerea si desfacerea suruburilor, oricat de ruginite sunt acestea, imposibil de facut manual.



Pre Comanda

CE
EGA Master
ART IN INNOVATION
AQUA Master

ZONE 1, 2 GAZ

79917	Nm	7300	51942.80
Categorie Atex	EX II2GcT5		
Presiune de lucru	70-140 bar		
Pentru suruburi si piulite	≤ M30 (46 mm AF)		
Cuplu maxim	1700 Nm		
Debit ulei	20-40 l/min		
Conexiune	M18x1,5		
Nivel zgomot	85,30 db		
Nivel vibratii	3,8 m/s ²		
Diametru recomandat furtun	12 mm Øint.		
Lungime	245 mm		
Greutate	7,3 kg		

79918

NOU

Masina de insurubat hidraulica pentru mediu subacvatic 1" 1700 Nm

- cheile hidraulice de impact EGA Master sunt instrumentele ideale pentru operatiuni subacvatice si operatiuni in atmosfere explozive: intretinere, reparatii si constructie
- esential pentru lucrarile de imersie, cum ar fi repararea si inspectia navelor, lucrarile de constructie si intretinere subacvatice
- esential pentru a lucra in zone periculoase precum industria petrolului, rafinarii, uzine chimice, minerit, lucrari subterane... etc.
- acesta este un instrument ideal pentru aplicarea cuplurilor mari la orice tip de surub datorita actiunii simple de declansare
- permite strangerea si desfacerea suruburilor, oricat de ruginite sunt acestea, imposibil de facut manual.



Pre Comanda

CE
EGA Master
ART IN INNOVATION
AQUA Master

ZONE 1, 2 GAZ

79918	Nm	7300	52375.47
Categorie Atex	EX II2GcT5		
Presiune de lucru	70-140 bar		
Pentru suruburi si piulite	≤ M30 (46 mm AF)		
Cuplu maxim	1700 Nm		
Debit ulei	20-40 l/min		
Conexiune	M18x1,5		
Nivel zgomot	85,30 db		
Nivel vibratii	3,8 m/s ²		
Diametru recomandat furtun	12 mm Øint.		
Lungime	245 mm		
Greutate	7,3 kg		

79919

NOU

Masina de insurubat hidraulica pentru mediu subacvatic 1" 2500 Nm

- cheile hidraulice de impact EGA Master sunt instrumentele ideale pentru operatiuni subacvatice si operatiuni in atmosfere explozive: intretinere, reparatii si constructie
- esential pentru lucrarile de imersie, cum ar fi repararea si inspectia navelor, lucrarile de constructie si intretinere subacvatice
- esential pentru a lucra in zone periculoase precum industria petrolului, rafinarii, uzine chimice, minerit, lucrari subterane... etc.
- acesta este un instrument ideal pentru aplicarea cuplurilor mari la orice tip de surub datorita actiunii simple de declansare
- permite strangerea si desfacerea suruburilor, oricat de ruginite sunt acestea, imposibil de facut manual.



Pre Comanda

CE
EGA Master
ART IN INNOVATION
AQUA Master

ZONE 1, 2 GAZ

79919	Nm	10700	69040.62
Categorie Atex	EX II 2G Ex h IIB T5 Gb		
Presiune de lucru	140 bar		
Pentru suruburi si piulite	≤ M36 (55 mm AF)		
Cuplu maxim	2500 Nm		
Debit ulei	25-45 l/min		
Conexiune	1/2"FF		
Diametru recomandat furtun	12 mm Øint.		
Greutate	10,7 kg		

79912

NOU

Masina de gaurit hidraulica pentru mediu subacvatic CM3 60 Nm

- masinile de gaurit EGA Master pentru utilizare subacvatica sunt solide, puternice si foarte usor de gestionat
- proiectate pentru gauri in mai multe tipuri de materiale in medii subacvatice: precum beton, carbune, piatra si de asemenea metal cu duritate medie.
- pot fi actionate cu ambele maini, oferind mai multa siguranta si confort la gaurire

Pre Comanda



CE
EGA Master
ART IN INNOVATION
AQUA Master

79912	Nm	kg	€
79912	60	8500	47289.54
Presiune de lucru	140 bar		
Mandrina	CM3		
Cuplu maxim	60 Nm		
Debit ulei	10 l/min		
Conexiune	1/2"FF		
Turatie mars in gol	280 rpm		
Putere	1,6 kW		
Nivel de sunet	85,2 db		
Nivel de vibratii	<15,8 m/s ²		
Diametru recomandat furtun	12 mm Øint.		
Greutate	10,7 kg		

79915

NOU

Masina de gaurit hidraulica pentru mediu subacvatic SDS-plus® 1,2 kW

- ciocanele hidraulice EGA Master sunt proiectate pentru a gauri suprafete foarte rezistente si dure in medii subacvatice.
- esentiale pentru gaurirea materialelor precum beton, caramida, piatra pe care burghiile conventionale nu le-ar putea gauri
- echipat cu un ambreiaj de siguranta care protejeaza impotriva supraincarcarilor si blocajelor
- sistem SDS-Plus
- un maner lateral reglabil si un indicator de adancime ofera un confort sport



Pre Comanda

CE
EGA Master
ART IN INNOVATION
AQUA Master

ZONE 1, 2 GAZ

79915	RPM	kg	€
79915	500	8200	55990.89
Presiune de lucru	80 bar		
Mandrina	SDS Plus		
Impacturi pe minut	4460 bpm		
Capacitate de gaurire	28 mm (beton) / 50 mm (zidarie)		
Debit ulei	10-45 l/min		
Conexiune	3/4"-16UNF		
Turatie mars in gol	500rpm		
Putere	1,2 kW		
Nivel de sunet	92 db		
Nivel de vibratii	4,5 m/s ²		
Lungime	460		
Greutate	8,2 kg		

79916

NOU

Masina de gaurit hidraulica pentru mediu subacvatic SDS-max1,2 kW

- ciocanele hidraulice EGA Master sunt proiectate pentru a gauri suprafete foarte rezistente si dure in medii subacvatice.
- esentiale pentru gaurirea materialelor precum beton, caramida, piatra pe care burghiile conventionale nu le-ar putea gauri
- echipat cu un ambreiaj de siguranta care protejeaza impotriva supraincarcarilor si blocajelor
- sistem SDS-max
- un maner lateral reglabil si un indicator de adancime ofera un confort sport



CE
EGA Master
ART IN INNOVATION
AQUA Master

Pre Comanda



ZONE 1, 2 GAZ

79916	RPM	kg	€
79916	270	14000	89889.87
Presiune de lucru	80 bar		
Mandrina	SDS max		
Impacturi pe minut	2300 bpm		
Capacitate de gaurire	50 mm (beton) / 80 mm (zidarie)		
Debit ulei	15-45 l/min		
Conexiune	3/4"-16UNF		
Turatie mars in gol	500rpm		
Putere	1,2 kW		
Nivel de sunet	92 db		
Nivel de vibratii	9 m/s ²		
Lungime	640		
Greutate	14,0 kg		

79432

NOU

Masina de gaurit cu talpa magnetica hidraulica pentru mediu subacvatic CM3, 2,5 kW



Pre Comanda

CE
EGA Master
ART IN INNOVATION
AQUA Master

ZONE 1, 2 GAZ

79432	RPM	kg	€
79432	40-250	22500	140678.20
Presiune de lucru	140 bar		
Mandrina	CM3		
Diametru maxim de gaurire	100 mm		
Fora magnetica	850 kg		
Debit ulei	20-23 l/min		
Conexiune	3/4"-16UNF		
Turatie mars in gol	40-250 rpm		
Putere	2,5 kW		
Nivel de sunet	79,8 db		
Nivel de vibratii	<2,5 m/s ²		
Cursa	300 mm		
Greutate	14,0 kg		

79913

NOU

Fierastrau pendular orizontal hidraulic pentru mediu subacvatic 2,8 kW

- EGA Master ofera o gama larga de scule pentru utilizare subacvatica printre care puteti gasi fierastrau portabil hidraulic, ideal pentru operatiuni subacvatice care necesita taierea tevilor, rezervoarelor, structurilor din otel, profilelor si a altor materiale.
- poate fi folosit atat in medii subacvatice, cat si in zonele ATEX
- este potrivit pentru cea mai dificila utilizare in rafinari, uzine chimice, in industria constructiilor, pe langa industria petrolului in larg, precum si in lucrari de demolare.
- este esential pentru lucrarile de imersie precum: intretinerea si repararea navelor, aparate plutitoare si instalatii scufundate, demolarea obstacolelor subacvatice; diguri, poduri, constructii subacvatice etc.
- este instrumentul ideal pentru taierea in spatii restranse
- proiectat pentru taierea tuburilor cu diametrul exterior de pana la 24"
- accepta panze de pana la 37"

Pre Comanda



CE
EGA Master
ART IN INNOVATION
AQUA Master

ZONE 1, 2 GAZ

79913	RPM	kg	€
79913	500	6100	49345.43
Categoria ATEX	Ex II2GcT5		
Presiune de lucru	140 bar		
Tip supapa	rasucire		
Cursa	60 mm		
Numar de lovituri	500 rpm		
Debit ulei	10-50 l/min		
Conexiune	3/4"-16UNF		
Putere	2,8 kW		
Nivel de sunet	86 db		
Nivel de vibratii	<2,5 m/s ²		
Furtun (Øint)	12 mm		
Greutate	6,1 kg		

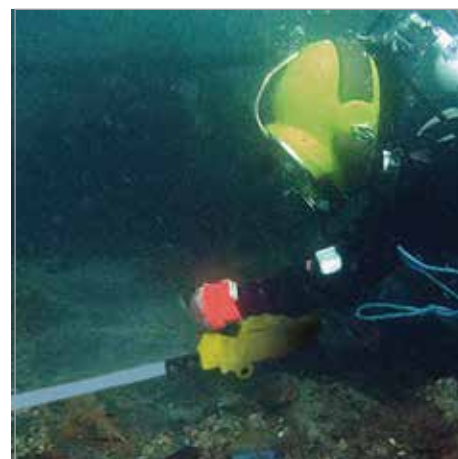

79914

NOU

Fierastrau sabie hidraulic pentru mediu subacvatic 1,5 kW

- EGA Master ofera o gama larga de scule pentru utilizare subacvatica printre care puteti gasi fierastraul sabie hidraulic, ideal pentru operatiuni subacvatice care necesita taierea tevilor, rezervoarelor, structurilor din otel, profilelor si a altor materiale.
- acesta este un instrument ideal pentru taierea rapida a tevilor, structurilor de otel, suruburilor, cuielei si a altor materiale in medii subacvatice
- esential pentru lucrari de imersie precum intretinerea si repararea navelor, aparate plutitoare si instalatii scufundate, platforme petroliere offshore, centrale hidraulice etc.
- dimensiunea sa compacta permite taierea in spatii inguste
- ofera cel mai bun raport putere-greutate
- este capabil sa taie lemn de pana la 152 mm si metal pana la 19 mm

Pre Comanda



CE

EGA Master
ART IN INNOVATION
AQUA Master

ZONE 1, 2 GAZ

79914	RPM	⚙️	⚖️
79914	1500	6000	42852.68
Categoria Atex Ex II 2G Ex h IIB T5 Gb			
Presiune de lucru 140 bar			
Tip supapa trigger			
Cursa 28 mm			
Numar de lovituri 1500 rpm			
Debit ulei 22-50 l/min			
Conexiune 1/2"FF			
Putere 1,5 kW			
Nivel de sunet 89,4 db			
Nivel de vibratii <2,5 m/s ²			
Furtun (Øint) 12 mm			
Greutate 6,1 kg			

79980

NOU

Fierastrau hidraulic cu lant pentru mediu subacvatic 7,7 kW

- EGA Master ofera o gama larga de scule pentru utilizare subacvatica printre care puteti gasi fierastraul cu lant hidraulic, ideal pentru operatiuni subacvatice
- esential pentru lucrari de imersie precum intretinerea si repararea navelor, aparate plutitoare si instalatii scufundate, platforme petroliere offshore, centrale hidraulice etc.
- dimensiunea sa compacta permite taierea in spatii inguste
- ofera cel mai bun raport putere-greutate

Pre Comanda



CE

EGA Master
ART IN INNOVATION
AQUA Master

ZONE 1, 2 GAZ

79980	RPM	⚙️	⚖️
79980	5000	10500	79789.92
Categoria Atex Ex II 2G c IIB T5			
Presiune de lucru 140-200 bar			
Turatie mars in gol 5000 rpm			
Debit ulei 40-50 l/min			
Conexiune 1/2"FF			
Putere 7,7 kW			
Nivel de sunet 85 db			
Nivel de vibratii <3,6 m/s ²			
Furtun (Øint) 12 mm			
Greutate 10,5 kg			

Bara lant

- esential pentru lucrari de imersie precum intretinerea si repararea navelor, aparate plutitoare si instalatii scufundate, platforme petroliere offshore, centrale hidraulice etc.



EGA Master
ART IN INNOVATION
AQUA Master

Pre Comanda

74752	Produs	⚖️
74752	Sina 27 mm	4734.22
79981	Sina 43 mm	4103.13
79983	Sina 63 mm	6961.78
74755	Sina 73 mm	12444.56
74770	Sina 103 mm	14825.25

Lant

- esential pentru lucrari de imersie precum intretinerea si repararea navelor, aparate plutitoare si instalatii scufundate, platforme petroliere offshore, centrale hidraulice etc.



EGA Master
ART IN INNOVATION
AQUA Master

Pre Comanda

74354	Produs	⚖️
74354	27 mm	3263.58
74359	43 mm	2930.27
79986	63 mm	3462.84
74362	73 mm	3787.52
74369	103 mm	5004.83

Lant cu dinti diamantati

- esential pentru lucrari de imersie precum intretinerea si repararea navelor, aparate plutitoare si instalatii scufundate, platforme petroliere offshore, centrale hidraulice etc.



EGA Master
ART IN INNOVATION
AQUA Master

Pre Comanda

79982	Produs	⚖️
79982	Lant cu dinti Diamont 43 cm	27443.16
74405	Lant cu dinti Diamont 43cm Universal	29434.25
74624	Lant cu dinti Diamont 43cm Durata mare	28135.56

Lant cu dinti din carbura

- esential pentru lucrari de imersie precum intretinerea si repararea navelor, aparate plutitoare si instalatii scufundate, platforme petroliere offshore, centrale hidraulice etc.



EGA Master
ART IN INNOVATION
AQUA Master

Pre Comanda

74372	Produs	⚖️
74372	27 mm	9126.07
74375	43 mm	10244.31
79985	63 mm	17855.30
74393	73 mm	20549.80
74996	103 mm	21816.02

Protectie lant

- esential pentru lucrari de imersie precum intretinerea si repararea navelor, aparate plutitoare si instalatii scufundate, platforme petroliere offshore, centrale hidraulice etc.



EGA Master
ART IN INNOVATION
AQUA Master

Pre Comanda

74785	Produs	⚖️
74785	43 mm	793.43
74785	63 / 73 mm	793.43

79920

NOU

Masina de carotat hidraulica pentru mediu subacvatic 2,8 kW

- EGA Master produce o gama larga de unelte subacvatice (subacvatice) masina de carotat hidraulica este una dintre ele
- permite realizarea de foraje subacvatice rapide si precise, pe multe suprafete de materiale diferite: piatra, caramida, beton
- 3 viteze de gaurire
- echipata cu un ambreiaj de siguranta care protejeaza impotriva supraincarcarilor si blocajelor
- manerul lateral reglabil la 360° permite lucrul in diferite pozitii
- control auto-reglabil al debitului de ulei



EGA Master
ART IN INNOVATION
AQUA Master

ZONE 1, 2 GAZ

79920	RPM	⚙️	⚖️
79920	380 / 900 / 1800	8500	57533.85
Presiune de lucru 140 bar			
Trepse turatie 380/900/1800 rpm			
Cuplu 60/38/17 Nm			
Carote standard 160 mm			
Debit ulei 22-45 l/min			
Conexiune 1/2"FF			
Putere 2,8 kW			
Lungime 480 mm			
Greutate 8,5 kg			



MASTEREX 76757**NOU****Pompa hidraulica cu actionare electrica**

• pompa hidraulica ATEX EGA Master 76757 nu numai ca ofera cele mai bune performante in ceea ce priveste presiunea si debitul pentru lucrul rapid si ergonomic, dar asigura si respectarea masurilor de siguranta cerute de Directiva 2014/34/UE pentru medii explozive

• aceste pompe sunt potrivite pentru operatiuni de ridicare prin actionarea cilindrilor hidraulici, pentru operatiuni de testare a presiunii si operatiuni de strangere hidraulica a suruburilor folosind chei dinamometrice hidraulice

• in conformitate cu directiva ATEX 2014/34/UE, astfel incat acestea pot fi utilizate in atmosfere explozive din zona 1 si zona 2 de risc

• capacitate rezervor de pana la 10 litri.

• motor electric trifazat, 1,1 kW

• supapă electrica pentru controlul cheii hidraulice

• accesorii incluse: cleste de impamantare, cadru cu roti, bloc cvadruplu pentru a utiliza pana la 4 chei dinamometrice, manometru 0/100 bar, telecomandă cu buton de control (cablu de 5 m) si supapa de evacuare externa reglabila



CE



ZONE 1, 2 GAZ

EGAMaster
ART IN INNOVATION
Pre Comanda

Putere			
76757	1,1 kW	45000	178102.31
Tensiune	400 V		
Putere	1,1 kW		
Capacitate	10 l		
Debit	7,5l/min. @ 70 bar / 0,9l/min @ 700 bar		
Porturi	4		
Categorie ATEX	EX II 2G Ex IIB T3 Gb X Tmax = +90°C		
Dimensiuni	520x520x640 mm		

79815**NOU****Ulei hidraulic**
EGAMaster
ART IN INNOVATION
Pre Comanda

	litri		
79815	20	18560	3084.25

79999**NOU****Furtune hidraulice**

- lungime: 10 m
- racorduri: 1/4"

EGAMaster
ART IN INNOVATION
Pre Comanda

	m		
79999	10	6500	22075.61