

CHEI



Durata lunga de viata

Cheile Unior sunt forjate din otel Crom Vanadiu de inalta calitate, iar partile supuse sarcinilor mari au o densitate mai mare, ameliorandu-le in acest fel duritatea.

Dimensiunile si procedeele de productie folosite maresc rezistenta si durata de viata



Profil de siguranta

Cu profilele sigure, cheile previn stricarea colturilor si a marginilor suruburilor si piulitelor distribuind sarcina in mod egal pe suprafata, la distanta de muchiile piulitelor si capetelor de surub, in loc sa actioneze direct pe acestea



Design inovator

Datorita designului inovator si concepiei rezultate dintr-o tehnologie de varf, cheile Unior garanteaza un transfer de forta la capetele de suruburi si piulite precis si eficient

O procedura speciala de productie a cheii combinate de 24 mm

1. Taiere: Bara plata de otel este taiata la forma dorita cu o masina; acuratetea taierii asigura consumul minim de material de calitate

2. Forjare: Prin procedurile de forjare efectuate cu presele LASCO de renume mondial, duritatea cheilor combinate este marita. Tehnicile de forjare de clasa mondiala ne permit sa mentinem orientarea optima a fibrelor de material (la fel ca in barele de otel) ceea ce este critic in produsele expuse la sarcini mari si dinamice.

3. Debavurare: Eliminarea bavurilor (reziduuri de material dupa forjare) este efectuata cu o masina specializata. Pentru o decupare corecta, greutatea bavurilor de eliminat trebuie sa fie inferioara celei a piesei forjate.

4. Perforare: Dupa etapele de forjare si debavurare, perforarile in piesa sunt facute prin ambutisare sau taiere. Acestea pot fi executate atat la rece cat si la cald.

5. Debavurare si slefuire: Prin tratamente mecanice sau chimice, muchiile ramase la forjare sunt rotunjite cu masini de debavurat, apoi contururile sunt slefuite cu materiale abrazive

6. Marcare si indoire: In concordanta cu ansamblul normelor, fiecare produs este marcat corespunzator; apoi inelul cheii este indoit dupa cerinta

7. Brosare: La bro sare, dimensiunea finala a cheii este facuta prin actiunea unei brose dotate cu mai multe lame. In uzinele Unior, profilul intern al inelului poligonal este obtinut cu masini de alezaj MAE.

8. Calire: Calirea prin incalzire si racirea ulterioara permit ameliorarea fibrelor de otel si in acelasi timp optimizarea duritatii cheii. Acest procedeu prin tratament termic permite cheilor Unior durabilitate crescuta si o rezistenta marita la forte mari

9. Sablare: Diverse substante abrazive sunt pulverizate pe suprafata cheilor UNIOR prin aer comprimat. Materiile abrazive curata suprafata cheii si furnizeaza asperitatea necesara aplicarii unui strat de protectie galvanica

10. Cromare si lustruire: Cheile sunt acoperite de un strat subtire de bioxid de crom pentru a le proteja impotriva coroziunii, uzurii sau altor fenomene agresive. Cromajul da de asemenea un aspect stralucitor, mai atractiv vizual



Chei fixe	28
Chei reglabile	34
Chei combinate	40
Chei inelare	45
Chei cu clichet	48
Chei de soc	49
Chei cu gheara	51
Chei pipa	53
Chei teava / chei pentru roti	51
Scule pentru lubrifi care si filtrare	62
Chei cu curea	63
Chei imbus	62



Rezistentă la torsiune 110/1 Chei fixe duble drepte

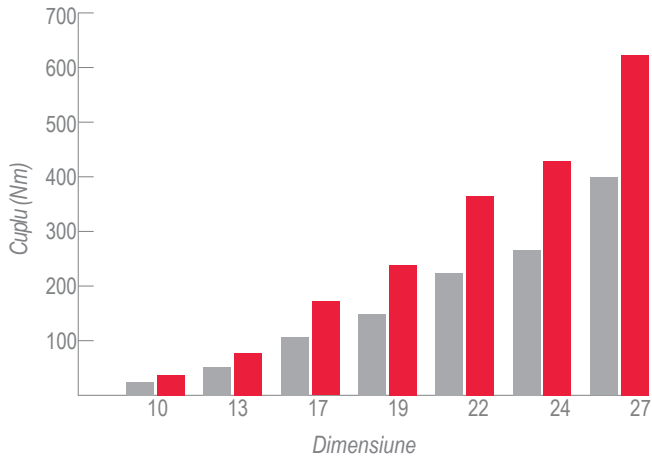

Rezistentă la torsiune 180/1 Chei inelare dublu cotite

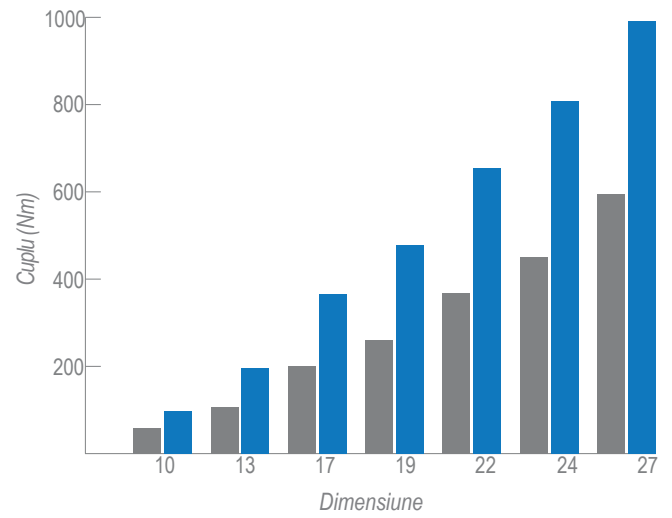

Rezistentă la torsiune 120/1 Chei combinate, varianta lunga

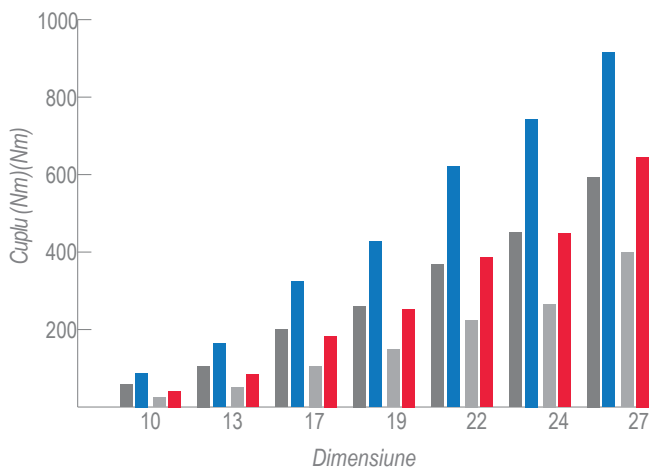

- ISO 1711-1 (A) cap cheie inelara
 - UNIOR cap cheie fixa
 - ISO 1711-1 (C) cap cheie fixa
 - UNIOR cap cheie inelara
- ISO si UNIOR in Nm

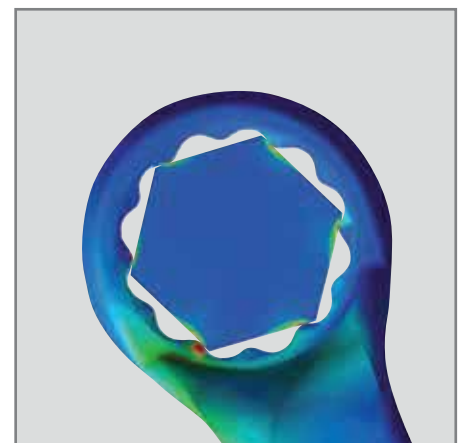
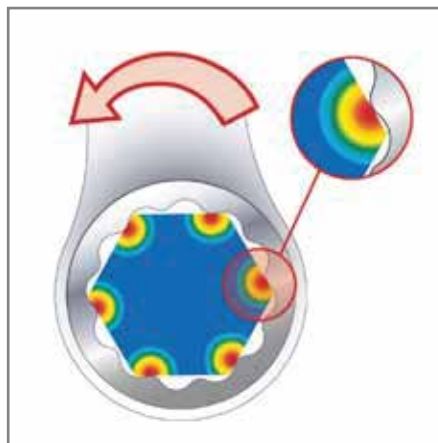

Cheie fixa dubla cromata DIN 3110

- cheia este forjată din oțel premium crom-vanadiu
- cheia se remarcă prin rezistența excepțională, durabilitatea și protecția suprafeței, care oferă utilizatorului o utilizare fiabilă și de lungă durată. Este o soluție completă pentru asigurarea suruburilor și piulițelor și un instrument indispensabil atât pentru profesioniști, cât și pentru pasionații de bricolaj.
- material: oțel premium crom vanadiu
- forjată, calire și revenire totală
- finisaj suprafață: cromat conform ISO 1456:2009
- cap lustruit
- realizat conform standardului ISO 10102 (doar dimensiunile în mm)
- capul cheii sub un unghi de 15°

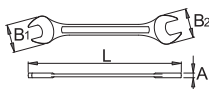
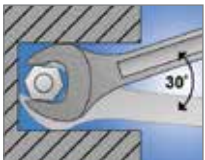

UNIOR Premium

Articol	Dimensiuni	L	B1	B2	A	Greutate	Pondere
603316	4 x 4.5	100	14	14	3.4	10	22.13
603317	4 x 5	100	14	14	3.4	10	22.13
603318	5 x 5.5	100	14	14	3.4	10	22.13
600060	5.5 x 7	121	14.4	16.4	3.4	15	25.41
600061	6 x 7	121	14.4	16.4	3.4	15	18.03
600062	7 x 8	140	18.4	22.9	3.7	24	20.98
600064	8 x 9	140	18.4	22.9	3.7	24	18.69
600065	8 x 10	140	18.4	22.9	3.7	23	22.95
600066	9 x 10	159	22.7	24.2	4.5	43	23.28
600067	9 x 11	159	22.7	24.2	4.5	40	25.41
600068	10 x 11	159	22.7	24.2	4.5	40	22.95
600069	10 x 12	172	26.2	29.2	4.9	58	27.05
600070	10 x 13	172	26.2	29.2	4.9	59	28.69
600072	11 x 13	172	26.2	29.2	4.9	58	28.69
600074	12 x 13	172	26.2	29.2	4.9	58	25.90
600075	12 x 14	172	26.2	29.2	4.9	58	28.69
600076	13 x 14	192	31.2	33.2	5.4	81	28.85
600077	13 x 15	192	31.2	33.2	5.4	84	29.51
600078	13 x 17	200	31.2	37.7	5.7	101	30.98
600079	14 x 15	192	31.2	33.2	5.4	83	27.70
600080	14 x 17	200	31.2	37.7	5.7	101	30.98
600081	15 x 17	206	35.7	37.7	5.7	108	34.75
600082	16 x 17	206	35.7	37.7	5.7	108	31.48
600083	17 x 19	223	39.5	41.5	6.2	143	35.57
600084	17 x 22	232	43.5	46	6.2	193	43.44
600085	18 x 19	223	39.5	41.5	6.2	148	35.08
600086	19 x 22	232	43.5	46	6.7	183	41.64
600088	20 x 22	232	43.5	46	6.7	180	40.49
600089	21 x 23	249	46	52	7.2	235	42.46
600090	22 x 24	249	46	52	7.2	237	46.07
600091	22 x 27	265	51.8	55.3	7.2	301	62.62
600092	24 x 26	265	51.8	55.3	7.7	289	51.64
600093	24 x 27	265	53.8	51.8	7.7	289	58.69
600095	25 x 28	279	62.8	53.8	8.2	344	56.72
600096	27 x 29	309	62.8	67.3	9.2	535	80.66
600097	27 x 30	309	62.8	67.3	9.2	527	82.30
600098	27 x 32	309	62.8	67.3	9.2	541	70.98
600099	30 x 32	309	62.8	67.3	9.2	532	76.89
603848	30 x 34	315	62.8	68.8	9.6	568	88.20
602593	30 x 36	319	62.8	78.8	9.6	591	137.87
600100	32 x 36	327	68.8	78.8	9.6	653	138.36
600101	34 x 36	327	68.8	78.8	9.6	628	166.39
600102	36 x 41	360	78.8	86.8	9.6	823	180.16
605549	38 x 42	360	78.8	86.8	9.6	822	210.00
602594	41 x 46	410	86.8	94.8	14.6	1735	262.46
602595	46 x 50	460	94.8	103.9	15.6	2365	349.51

Articol	Dimensiuni	L	B1	B2	A	Greutate	Pondere
605348	1/4" x 5/16"	121	14.4	16.4	3.4	15	19.51
605349	5/16" x 3/8"	140	18.4	22.9	3.7	24	20.33
605350	3/8" x 7/16"	159	22.7	24.2	4.5	40	24.75
605351	7/16" x 1/2"	172	26.3	29.2	4.9	58	30.00
605352	1/2" x 9/16"	192	31.2	33.2	5.4	81	30.00
605353	9/16" x 5/8"	192	31.2	33.2	5.4	83	30.00
605354	5/8" x 11/16"	206	35.7	37.7	5.7	108	34.10
605355	11/16" x 3/4"	223	39.5	41.5	6.2	143	38.03
605356	13/16" x 7/8"	249	46	52	7.2	237	43.77
605357	15/16" x 1"	265	51.8	55.3	7.7	301	56.23
605358	1" x 1.1/8"	279	53.8	58.8	8.2	344	61.48
605359	1.1/16" x 1.1/4"	309	62.8	67.3	9.2	527	76.23



Nu folosiți niciodată o prelungire sau orice formă de parghie pentru a crește efectul de parghie al unei chei.



Nu le folosiți pentru a elibera o piuliță ruginită sau pentru a finaliza o strângere astfel de piuliță.



Piulița trebuie să fie întotdeauna complet așezată înainte de utilizare.



Nu folosiți niciodată un ciocan pe chei.



Nu expuneți niciodată nici o cheie la căldura excesivă, care poate modifica duritatea și structura metalică și poate deteriora unealta.



Cheile nu trebuie slefuite pentru a-și schimba forma.



Nu folosiți o cheie care a fost deteriorată și slăbită prin indoire, crapare sau uzură gravă.



Folosiți doar forța manuală, nu folosiți niciodată nici o formă de parghie pentru a crește efectul de parghie.



Selectați o cheie a cărei deschidere se potrivește exact cu piulița aleasă.



Trageți întotdeauna în loc să împingeți și mențineți întotdeauna o poziție adecvată cu picioarele ferme pentru a vă menține echilibrul.



Inspectia periodică a uneltelor de mână de către personal competent este o necesitate de siguranță.

Premium

Premium chrome vanadium steel

Fiabilitate fara uzura

Atunci când vine vorba de unelte, cum ar fi clești și clește de teava, de exemplu, care trebuie să reziste la încărcături mari, sunt de o importanță deosebită proprietăți precum rezistența ridicată la tracțiune, ductilitatea corespunzătoare a materialului cu o elasticitate mai mare și cea mai mică susceptibilitate la crapare. Aceste cerințe sunt îndeplinite în mod deosebit de oțelul premium crom / vanadiu, oțel aliat cu mangan, crom, siliciu și carbon. Unele realizate din acest oțel au o durată lungă de viață și sunt o alegere excelentă pentru mulți ani de utilizare



Set de chei fixe in cutie de carton



UNIOR Premium

Articol	Dimensiuni	Greutate	Pondere
602844	6 - 22 / 8	800	1 220.33
110/1 (6 x 7, 8 x 9, 10 x 11, 12 x 13, 14 x 15, 16 x 17, 18 x 19, 20 x 22)			

Set de chei fixe in husa textila



CT110 (430 x 275)

UNIOR Premium

Articol	Dimensiuni	Greutate	Pondere
615465	6 - 22 / 8	788	1 336.23
110/1 (6 x 7, 8 x 9, 10 x 11, 12 x 13, 14 x 15, 16 x 17, 18 x 19, 20 x 22)			

Set de chei fixe in cutie de carton



UNIOR Premium

Articol	Dimensiuni	Greutate	Pondere
600105	6 - 22 / 8	724	1 220.33
110/1 (6 x 7, 8 x 9, 10 x 11, 12 x 13, 14 x 15, 16 x 17, 18 x 19, 20 x 22)			
600106	6 - 32 / 12	2140	1 442.30
110/1 (6 x 7, 8 x 9, 10 x 11, 12 x 13, 14 x 15, 16 x 17, 18 x 19, 20 x 22, 21 x 23, 24 x 26, 25 x 28, 27 x 32)			
600107	6 - 41 / 13	3982	1 622.46
110/1 (6 x 7, 8 x 9, 10 x 11, 12 x 13, 14 x 15, 16 x 17, 18 x 19, 20 x 22, 21 x 23, 24 x 26, 25 x 28, 27 x 32, 36 x 41)			
611018	6 - 27 / 10	1250	1 321.48
110/1 (6 x 7, 8 x 9, 10 x 11, 12 x 13, 14 x 15, 16 x 17, 18 x 19, 20 x 22, 21 x 23, 24 x 27)			
605531	1/4" - 1.1/4" / 12	2005	1 464.43
110/1 (1/4" x 5/16", 5/16" x 3/8", 3/8" x 7/16", 7/16" x 1/2", 1/2" x 9/16", 9/16" x 5/8", 5/8" x 11/16", 11/16" x 3/4", 13/16" x 7/8", 15/16" x 1", 1" x 1.1/8", 1.1/16" x 1.1/4")			

CT110

Husa textila goala pentru chei fixe

- dimensiune 430 x 275, pentru articolul 110 in 125
- fixarea velcro este folosita pentru inchierea si deschiderea usoara
- cureaua de inchidere nu este necesara
- material: tesatura de poliester



UNIOR

	A	B			
615480	430	275	117	1	115.90

110/1PB

Set de chei fixe in husa de plastic



UNIOR Premium

600108	6 - 17 / 6	378	1	151.31
	110/1 (6 x 7, 8 x 9, 10 x 11, 12 x 13, 14 x 15, 16 x 17)			

110/1PB

Set de chei fixe in husa de plastic



UNIOR Premium

600109	6 - 22 / 8	474	1	230.00
	110/1 (6 x 7, 8 x 9, 10 x 11, 12 x 13, 14 x 15, 16 x 17, 18 x 19, 20 x 22)			

110/1MS

Set de chei fixe cu suport metalic



UNIOR Premium

605528	6 - 32 / 12	2740	1	526.72
	110/1 (6 x 7, 8 x 9, 10 x 11, 12 x 13, 14 x 15, 16 x 17, 18 x 19, 20 x 22, 21 x 23, 24 x 26, 25 x 28, 27 x 32), 977/1 (6 - 32/12)			

110/1MS

Set de chei fixe cu suport metalic



UNIOR Premium

605532	1/4" - 1.1/4" / 12	2642	1	548.85
	110/1 (1/4" x 5/16", 5/16" x 3/8", 3/8" x 7/16", 7/16" x 1/2", 1/2" x 9/16", 9/16" x 5/8", 5/8" x 11/16", 11/16" x 3/4", 13/16" x 7/8", 15/16" x 1", 1" x 1.1/8, 1.1/16" x 1.1/4"), 977/1			

977/1

Suport metalic pentru chei fixe

- material: tabla
- vopsite cu vopsele ecologice fara cadmiu si plumb

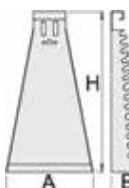

UNIOR

	L	B	H			
605160	180	50	330	420	1	84.43

114/2

Chei fixe duble mici pentru electricieni

- material: otel carbon de scule
- capul cheii este tratat in intregime
- acoperire cromare conform ISO 1456:2009

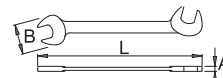

UNIOR

		L	B	A			
618623	3.2	75	10	2	2	18.03	
618624	3.5	75	10	2	2	18.03	
618625	4	75	10.5	2	2	18.03	
618626	4.5	75	10.5	2	2	18.03	
618627	5	85	12	2	4	19.67	
618628	5.5	85	12.2	2	4	19.67	
618629	6	85	12.5	2	4	19.67	
618630	7	95	14.5	2	6	21.48	
618631	8	95	16.5	2	7	21.48	
618632	9	110	19	3	17	24.43	
618633	10	110	21	3	18	24.43	
618634	11	110	23.5	3	20	25.25	
618635	12	125	24	3	30	30.66	
618636	13	125	27.5	3	33	30.66	
618637	14	125	28	3	33	30.66	

114/2PB

Set chei fixe mici pentru electricieni



UNIOR

619287	3.2 - 14 / 15	292	1	355.57
	114/2 (3.2, 3.5, 4, 4.5, 5, 5.5, 6, 7, 8, 9, 10, 11, 12, 13, 14)			

135/2

Cheie fixa simpla pentru gaz

- confectionata din tabla
- acoperire cromare conform EN12540

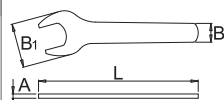

UNIOR

		L	B1	B2	A		
600262	27	187	52	22	4	149	26.72

7112/2

Cheie fixa dubla dreapta DIN 895

- ideala pentru strangerea si desfacerea suruburilor si piulitelor cu cap hexagonal
- in conformitate cu DIN 895 - ISO 3318 - 1085
- duritate material: 44-50 HRC
- forjat din otel special pentru scule cu rezistenta la rupere de 1200-1400 N/mm², calit pentru aplicatii cu cuplu mare, de exemplu, constructii, industrie grea, cai ferate, santiere navale, mine, agricultura, platforme petroliere etc.
- rezistenta ridicata la incoviere: nu se rupe si nu se curbeaza atunci cand este supraincercata
- ergonomie: profil proiectat pentru mai multa eficienta, de ex. capat deschis inclinat la 15°
- finisare: fosfatata (previne coroziunea si actioneaza ca un tratament anti-frietiune)
- marcaj din forjare: KRONUS, DIN 895 si dimensiunile cheii



KRONUS
Professional Quality

Barcode	⊖	L	A	B	C	D	E	F	⊞	⊞	⊞
71120607	6 x 7	95	6.5	14	7.5	16	3.2	3.5	20	3.14	
71120809	8 x 9	105	8.5	18	9	20	4.5	4	32	3.56	
71120911	9 x 11	105	8.5	18	9	20	4.5	4	32	5.88	
71121011	10 x 11	124	11	21	12	23	5	5	35	4.19	
71121012	10 x 12	124	11	21	12	23	5	5	35	6.11	
71121013	10 x 13	130	11	22	13	28	5.5	5.5	50	4.19	
71121113	11 x 13	130	11	22	13	28	5.5	5.5	50	4.79	
71121213	12 x 13	135	12	25	14	28	5.5	5.5	50	4.81	
71121214	12 x 14	135	12	25	14	28	5.5	5.5	50	6.33	
71121316	13 x 16	135	12	25	14	28	5.5	5.5	50	7.24	
71121317	13 x 17	155	14	29	16	34	6	6	80	6.39	
71121415	14 x 15	150	14	29	16	34	6	6	75	6.07	
71121417	14 x 17	160	14	29	18	35	6.5	6.5	80	6.61	
71121617	16 x 17	160	16	33	18	35	6.5	6.5	85	7.12	
71121618	16 x 18	160	16	33	18	35	6.5	6.5	85	9.05	
71121719	17 x 19	170	16	35	19	36	7	7.5	135	9.42	
71121720	17 x 20	170	16	35	19	36	7	7.5	135	13.12	
71121819	18 x 19	170	16	35	20	38	7	7.5	130	9.42	
71121821	18 x 21	170	16	35	20	38	7	7.5	130	14.70	
71121922	19 x 22	190	19	37	22	45	8	8	170	9.63	
71121924	19 x 24	190	19	37	22	45	8	8	170	15.38	
71122022	20 x 22	195	19	38	22	45	8.5	8.5	165	9.83	
71122123	21 x 23	220	22	44	23	48	8.5	9	200	11.72	
71122224	22 x 24	220	23	44	24	49	9	9	200	13.82	
71122426	24 x 26	240	24	49	26	55	9.5	10	260	16.32	
71122427	24 x 27	240	24	49	26	55	9.5	10	260	17.57	
71122430	24 x 30	240	24	49	26	55	9.5	10	260	27.15	
71122528	25 x 28	250	25	50	28	55	9.5	10	350	19.65	
900709	27 x 30	270	26	55	29	60	10	10	340	29.54	
71122732	27 x 32	270	28	60	30	65	10	10	400	24.06	
71123032	30 x 32	270	28	60	30	65	11	11	450	25.53	
900710	30 x 36	300	29	60	35	70	12	13	600	41.61	
71123236	32 x 36	300	30	65	36	70	12	13	650	35.18	
71123436	34 x 36	310	33	70	37	75	12	13	700	46.89	
71123438	34 x 38	310	33	70	37	75	12	13	720	46.89	
71123641	36 x 41	340	37	75	42	85	14	14	750	49.18	
71124146	41 x 46	370	41	80	43	90	15	14	900	103.66	
71124650	46 x 50	400	48	90	50	100	15	15	1500	126.05	
71125055	50 x 55	450	48	100	55	110	16	15	1600	188.47	
71125560	55 x 60	495	48	110	55	120	18	20	2150	242.66	
71126570	65 x 70	580	65	140	70	140	23	23	3550	768.72	
71127580	75 x 80	660	85	170	85	160	28	26	5600	920.96	

112/2

Cheie fixa dubla dreapta DIN 895

- material: otel carbon de scule
- forjata, calire si revenire totala
- acoperire cromare conform ISO 1456:2009
- executie in concordanta cu standardul DIN 895

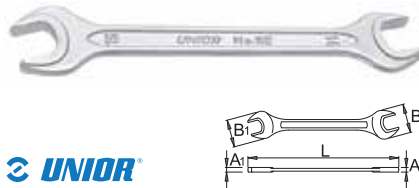

Barcode	⊖	L	B1	B2	A1	A2	⊞	⊞	⊞
602082	8 x 10	115	18	22	4.2	4.2	20	10.49	
613222	10 x 11	122	23	24.5	5	5	35	11.64	
605045	10 x 12	128	22	28	5	5	37	11.64	
603611	10 x 13	137	26	28.5	5.2	5.2	43	11.64	
602083	11 x 13	132	26	28.5	5	5.4	41	11.64	
602085	13 x 15	152	28	32	6	6	63	13.77	
603134	13 x 17	158	30	35	6.5	6.5	65	14.10	
602086	14 x 17	158	30	35	6.5	6.5	62	15.25	
602087	17 x 19	170	35	40	7	7	94	18.85	
602088	19 x 22	197	42	48	8	8	138	22.79	



895B

Cheie fixa dubla dreapta DIN 895

- material: otel carbon de scule
- forjata, calire si revenire totala
- acoperire cromare conform ISO 1456:2009
- executie in concordanta cu standardul DIN 895

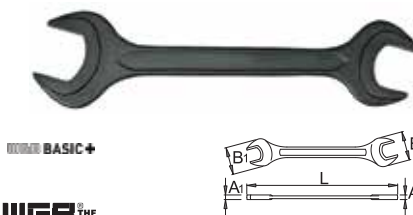

Barcode	⊖	L	⊞	⊞	⊞
6506070	6x7	93	10	10.63	
6508090	8x9	105	21	11.39	
6514150	14x15	149	61	17.72	
6516170	16x17	162	77	17.72	
6518190	18x19	169	96	22.70	
6519220	19x22	199	144	30.47	
6519240	19x24	205	166	41.78	
6521230	21x23	210	156	47.51	
6524270	24x27	237	269	55.28	
6525280	25x28	234	233	85.67	
6527320	27x32	256	382	89.81	
6530340	30x34	273	420	99.84	
6532360	32x36	303	480	122.54	
6550550	50x55	480	1895	386.70	
6555600	55x60	479	2100	427.05	

7112/2CT

Set de chei fixe cu husa textila



Barcode	⊖	L	⊞	⊞	⊞
900597	6 - 22 / 8		724	1	45.84
7112/2	(6 x 7, 8 x 9, 10 x 11, 12 x 13, 14 x 15, 16 x 17, 18 x 19, 20 x 22)				
900642	6 - 32 / 12		2140	1	117.58
7112/2	(6 x 7, 8 x 9, 10 x 11, 12 x 13, 14 x 15, 16 x 17, 18 x 19, 20 x 22, 21 x 23, 24 x 26, 25 x 28, 27 x 32)				

7117

Chei fixe simple drepte brunate DIN 894

- forjate din otel special pentru scule calit si revenit la 120 kg/mm² pentru aplicatii cu cuplu ridicat, de exemplu, constructii, industrie grea, cai ferate, santiere navale, mine, agricultura, platforme petroliere etc.
- falcile prelucrate la dimensiunea exacta
- corp extra lung pentru aplicatii in profunzime
- rezistenta mare la incoviere: cheia nu se rupe si nu se aseaza atunci cand este supraincercata
- ergonomie: profil proiectat pentru mai multa eficienta, capat deschis inclinat la 15°.
- finisare: fosfatata

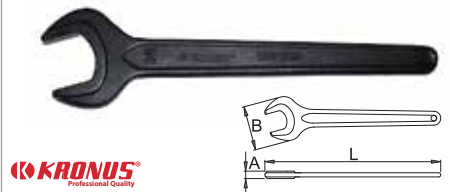

Barcode	⊖	L	A	B	⊞	⊞	⊞
900607	17	157	6.5	36	68	10.97	
715273	36	295	12.5	74	438	29.45	
715275	41	335	13.5	84	537	37.22	
715276	46	365	14.5	94	747	54.19	
715277	50	400	15.5	102	890	80.10	
715278	55	475	16	110	1170	103.66	
715279	60	475	17	120	1365	171.97	
715280	65	550	18	130	1665	188.47	
715281	70	550	19	140	1995	287.42	
715282	75	620	20	150	2995	372.23	
902345	80	665	21	160	4800	542.95	

894B

Chei fixe simple drepte brunate DIN 894

- material: crom vanadiu
- forjata, calire si revenire totala
- acoperire prin brunare conform cu standardul DIN 12476
- executie in conformitate cu standardul DIN 894



Barcode	⊖	L	⊞	⊞	⊞
6410500	105	900	6200	3778.86	
6411000	110	910	6350	4263.90	
6411500	115	950	6400	4718.54	
6412000	120	1005	8200	8464.51	
6412500	125	1005	7650	10208.24	
6413000	130	1005	7400	10523.09	
6413507	135	1005	7800	13847.58	



117/4

Cheie fixa dubla dreapta DIN 895

- material: crom vanadiu
- forjată, calire și revenire totală
- acoperire prin brunare conform cu standardul DIN 12476
- execuție în conformitate cu standardul DIN 894
- aplicații: în industrie pentru lucrări la utilaje, motoare și alte echipamente
- dimensiunile mari sunt utile în industria navală, industria petrolieră și alte sectoare grele unde se utilizează echipamente mari.
- cheia este special destinată pentru lucrări ce necesită momente de torsiune mari și parghii mai lungi pentru acționare



Premium
UNIOR

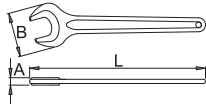

Barcode	⊖	L	A	B	⊖	⊖
615262	10	104	4.5	22	21	11.15
620207	12	123	5	26	29	11.15
615263	13	132	5.4	28	35	13.11
615264	17	157	6.5	36	68	13.61
615265	19	170	6.9	40	78	16.89
615267	22	195	7.9	46	106	20.00
615268	24	218	9.2	50	147	26.72
615269	27	240	9.7	56	192	31.48
615270	30	267	11.1	63	297	37.87
615271	32	267	11.7	66	297	42.13
615272	34	295	12.5	74	399	52.95
615273	36	295	12.5	74	438	58.03
615274	38	295	12.5	74	390	64.92
615275	41	335	13.5	84	537	70.00
615276	46	365	14.5	94	747	85.41
615277	50	400	15.5	102	890	144.43
615278	55	475	16	110	1170	231.80
615279	60	475	17	120	1365	311.48
615280	65	550	18	130	1665	425.74
615281	70	550	19	140	1995	434.26
615282	75	620	20	150	2995	529.51
615283	80	665	21	160	3895	624.92
615285	90	740	23	190	4795	712.13



250/1

Cheie reglabila

- material: crom vanadiu
- forjată, calire și revenire totală
- acoperire cromare conform EN12540
- capete polizate
- cu scala
- în conformitate cu standardul DIN 3117, ISO 6787

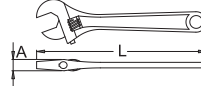

UNIOR Premium

Barcode	✓	L	A	⊖	⊖	⊖	
611917	100	110	9.8	17	10	61	114.59
611918	150	155.5	11.7	23	10	133	122.79
601016	200	205	14.4	28	10	243	139.51
601017	250	254	16.9	32	10	439	172.95
601018	300	303.5	19.1	38	10	702	233.93
601019	380	375	23.8	50	5	1315	418.52
605113	450	458.5	26.3	60	1	1730	666.89
615148	600	608	29.7	70	1	3240	1423.93

250/1ADP

Cheie reglabila

- material: crom vanadiu, forjată, calire și revenire totală
- acoperire cromare conform EN12540
- capete polizate
- cu scala
- manere din două straturi de plastic
- în conformitate cu standardul DIN 3117, ISO 6787

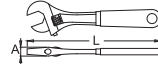

UNIOR Premium

Barcode	✓	L	A	⊖	⊖	⊖
617246	200	205	14.8	28	280	161.97
617247	250	254	17	32	490	188.85
617248	300	304	20	38	785	245.74
617249	380	381	25.5	50	1395	448.03

251/4

Cheie reglabila

- material: crom vanadiu, forjată, calire și revenire totală
- acoperire prin brunare
- rotire stanga, cu scala
- în conformitate cu standardul DIN 3117, ISO 6787

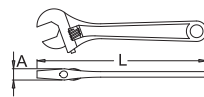

UNIOR Premium

Barcode	✓	L	A	⊖	⊖	⊖	
612870	150	155.7	11.7	20	137	10	94.36
612871	200	204.3	14.4	25	257	10	107.00
612872	250	254	16.9	30	447	10	132.61
612873	300	303.5	19.1	36	700	10	179.25

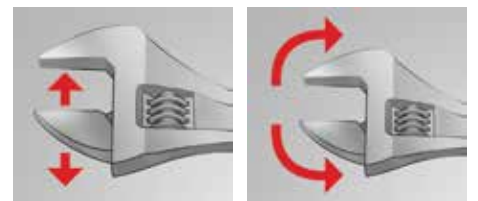
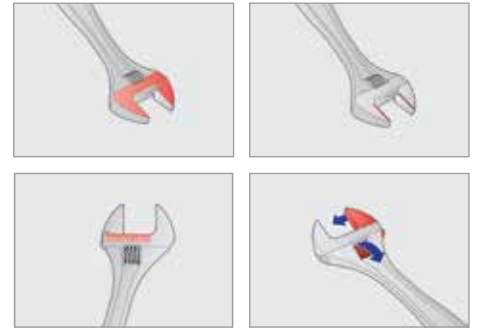

Falca reglabila

Cheia poate lucra in ambele sensuri

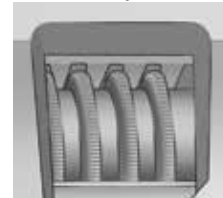

Moleta de reglaj

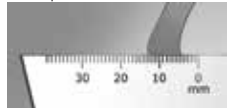

Scala de masura

IREGA 77/CE

Cheie reglabila cromata cu falci la 15°

- material: otel crom vanadiu
- scala de masurare metric pe falci pentru presetare si masurare piulite, suruburi, tevi, etc.
- fabricate in conformitate cu cele mai stricte standarde internationale UNE 16-532, ISO 6787, ASME B107.8M, BS ISO 6787 si DIN 3117

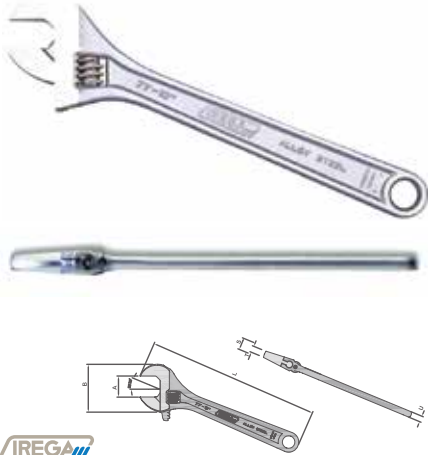

IREGA	L	B	S	T	U	Icon	Icon	Icon
570000015009003	385	119	25	15	11.5	43.12	1230	306.56
570000018009003	461	145.5	30	17.5	13.5	53	2010	468.85
570000024009003	612	152	34	20	15.5	62	3560	1302.30

IREGA 99F

Cheie reglabila fosfatata cu falci la 15°

- material: otel crom vanadiu
- scala de masurare metric pe falci pentru presetare si masurare piulite, suruburi, tevi, etc.
- fabricate in conformitate cu cele mai stricte standarde internationale UNE 16-532, ISO 6787, ASME B107.8M, BS ISO 6787 si DIN 3117

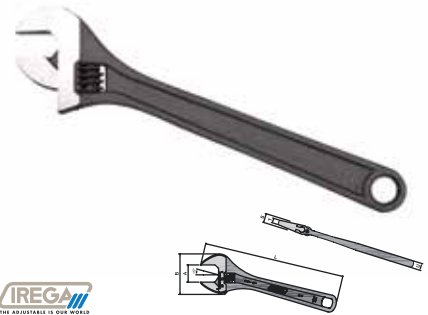

IREGA	L	B	S	T	U	Icon	Icon	Icon
570530106005103	160	49	10.8	5.8	5.7	19.2	130	120.98
570530108005103	206	62	13.5	7	9.7	24.05	250	150.00
570530110005103	257	73	16	8	11.2	29	410	180.16
570530112005103	310	85	19	10	13.2	34	690	241.64



Nu trageți niciodată de o cheie care are o potrivire slabă după ce a fost reglată cu un dispozitiv de fixare. Ajustați întotdeauna strans o cheie reglabila pentru a se potrivi pe piulița.

Nu folosiți niciodată un ciocan pe cheie.



Cheile trebuie ajustate strans la piulița și trase astfel încât forța să fie pe partea falci fixe.

Inspectia periodică a uneltelor de mână de către personal competent este o necesitate de siguranță.

IREGA 771-30"

Cheie reglabila cromata cu falci la 15°

- cheia reglabila 771-30" este ideala pentru cele mai grele și cele mai solicitante locuri de munca, în industrie, petrol, minerit, construcții metalice etc.
- fabricate în conformitate cu cele mai stricte standarde internationale
- depășește UNE 16-532
- forjate dintr-o singură bucată
- material: otel crom vanadiu
- rezistență mare, uzură minimă, durabilitate imbatăbilă
- scala de măsurare metric pe falci pentru măsurare piulite, suruburi, tevi, etc.

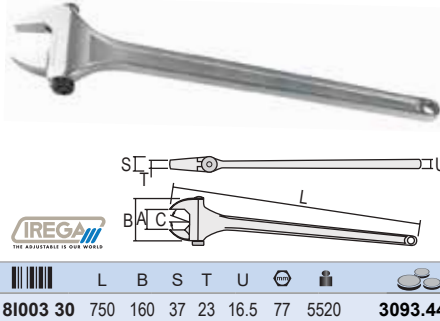

IREGA SWO 77/CE - 8"

Cheie reglabila cu deschidere marita

- greutate redusă
- compactă: "Stubby"
- robustă și versatilă
- instrument universal de înaltă performanță ideal pentru: instalații, centrale termice, aer condiționat, sistem de refrigerare, lucrări de întreținere, etc.

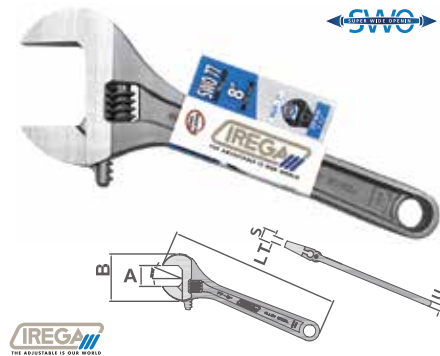

IREGA	L	B	S	T	U	Icon	Icon	Icon
570703008005003	211	76	14	6.9	10	39	315	165.08

IREGA 92LWD

Cheie reglabila cu greutate redusă

- greutate redusă
- finisaj triplu cromat (2 Ni + 1 Cr) pentru aderență perfectă a cromului și rezistență maximă la rugina
- maner din plastic pentru o mai bună aderență și confort
- maner cu profil ușor și subțire pentru greutate redusă
- scala de măsurare metric pe falci pentru măsurare piulite, suruburi, tevi, etc.

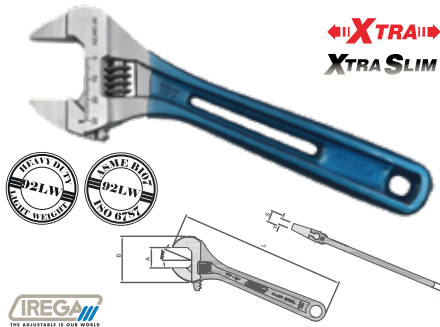

IREGA	L	S	T	U	Icon	Icon	Icon
571822006005105	161	10.8	4	5.0	24	130	198.52
571822008005105	207	14	5	6.0	30	250	232.79
571822010005105	259	15.8	6	6.5	36	410	283.44
571822012005105	311	19	8	8.1	46	690	378.52



IREGA 99XS

Cheie reglabila fosfatata Extra Slim

- material: otel crom vanadiu
- scala de măsurare metric pe falci pentru presetare și măsurare piulite, suruburi, tevi, etc.
- accesibilitate mai mare datorită designului falciilor Slim Xtra: până la 50% mai ușoare decât cheile standard, cu o deschidere similară
- cea mai mare accesibilitate garantată datorită grosimii reduse, pe toată lungimea falciilor Xtra Slim
- conform ISO 6787 și ASME B107.8



XTRA SLIM «XTRA»

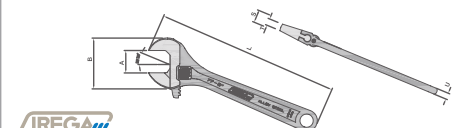

IREGA	L	B	S	T	U	Icon	Icon	Icon
571248104005106	114	35	9.5	2.5	6.3	13	50	138.52
571430106005106	161	50	10.8	2.5	8.0	24	125	151.97



IREGA SWO 99

Cheie reglabila fosfatata cu deschidere marita cu manson ErgoTop

- material: otel crom vanadiu
- maner ergonomic si interschimbabil ErgoTop
- SWO 99 6" deschidere marita 34 mm (1 3/8") cu 78% mai mare decat cheile reglabile standard (6"), dimensiuni similare; greutatea redusa - 205 grame cu 68% mai usoara decat chei reglabile standard (12") cu deschidere similara
- SWO 99 8" deschidere marita 39 mm (1 1/2") cu 62% mai mare decat cheile reglabile standard (8"), dimensiuni similare; greutatea redusa - 345 grame cu 50% mai usoara decat chei reglabile standard (12"), care are deschidere mai mica

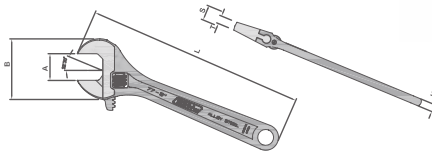

	L	B	S	T	U			
570433106008105	176	65	14	6.69	18	34	220	189.84
570433108008105	216	73	14	6.23	21	39	345	204.92

IREGA 92WR

Cheie reglabila cromata cu falca reversibila

- falca reversibila pentru prelucrarea tevilor
- capacitate mare de prindere
- scara dubla: milimetri de pe partea din fata, inch pe partea din spate
- cheie reglabila profesionala multifunctionala, se poate utiliza pe orice obiect cu forma cilindrica
- material: otel crom vanadiu
- usoara si compacta
- in conformitate cu cele mai stricte standarde internationale UNE 16532: 2002; ISO 6787: 2001; BS ISO 6787: 2001; ASME B107.100-2010 (B107.8); DIN 3117

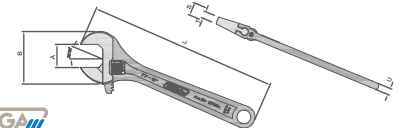

	L	S	T	U			
571101006005306	161	10.8	5.3	8.0	27	140	176.72
571101008005306	207	14	7.3	10.0	34	280	219.18
571101010005306	259	15.8	7.8	11.5	40	450	262.95
571101012005303	311	19	9.8	13.5	45	730	352.79

Dimensiunile sunt exprimate in milimetri daca nu se specifica altfel.
In conformitate cu standardele internationale ISO 6787 si ASME B107.8

O Falca reversibila cu XTRA capacitate permite lucrul cu suruburi de dimensiuni foarte mari, precum si aplicatii pe tevi cu aceeasi cheie reglabila.



GARANTIA IREGA

Toate cheile reglabile IREGA sunt realizate la cele mai inalte standarde si sunt garantate impotriva oricarui defect de fabricatie sau material.

IREGA SWO 99XS

Cheie reglabila fosfatata Extra Slim (4,5 mm) cu manson ErgoTop

- accesibilitate mai mare datorita designului falcilor Slim Xtra: pana la 50% mai subtire decat cheile standard, cu o deschidere similara
- material: otel crom vanadiu
- maner ergonomic si interschimbabil ErgoTop
- SWO 99XS 6" - deschidere cu 78% mai mare decat la chei reglabile standard, dimensiuni similare si greutatea redusa - 200 grame - cu 68% mai usoara decat cheile reglabile standard, cu deschidere similara
- SWO 99XS 8" - deschidere mare de 39 mm (1 1/2") cu 62% mai mare decat la chei reglabile standard si greutatea redusa, 335 gr - cu 50% mai usoara decat cheile reglabile standard (12"), care are deschidere mai mica



	L	B	S	T	U			
571033106005105	176	35	9.5	2.5	6.3	13	50	214.26
571033108005105	216	50	10.8	2.5	8.0	24	125	229.67



Falca reversibila pentru lucru pe tevi

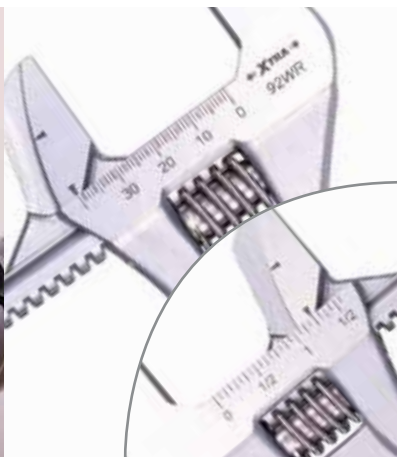

Scala dubla (mm si inch)



Cheie reglabila profesionala multifunctionala



IREGA calitate asigurata 100%

120/1

Cheie combinata, varianta lunga

• cheia este forjată din oțel premium crom-vanadiu
 • cheia se remarcă prin rezistența excepțională, durabilitatea și protecția suprafeței, care oferă utilizatorului o utilizare fiabilă și de lungă durată. Este o soluție completă pentru asigurarea suruburilor și piulițelor și un instrument indispensabil atât pentru profesioniști, cât și pentru pasionații de bricolaj.

• material: oțel premium crom vanadiu
 • forjată, calire și revenire totală
 • acoperire cromare conform EN12540

• cap lustruit
 • în concordanță cu standardul ISO 7738 (numai dimensiunile în mm)
 • capul cheii sub un unghi de 15°

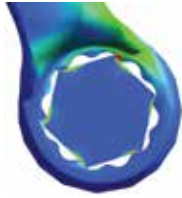
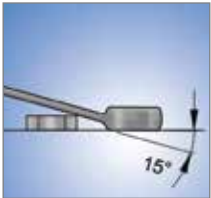

LIFE profile

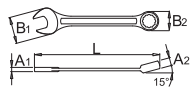

UNIOR Premium

Barcode	⊖	L	B2	B1	A2	A1	📦	🔩
616745	3.2	105	8	14	4	3.2	11	31.31
616746	4	105	8	14	4	3.2	11	31.31
616747	4.5	105	8	14	4	3.2	7	31.31
616748	5	119	10.4	14.5	5	3.5	7	31.31
616749	5.5	119	10.4	14.5	5	3.5	15	31.31
600357	6	119	10.4	14.5	5	3.5	14	25.90
600358	7	129	11.5	16.5	5.8	3.9	15	26.07
600359	8	141	13.2	18.5	6.9	3.9	23	26.56
600360	9	152	14.3	21	7.3	4	27	30.16
600361	10	163	15.9	23	7.5	4.2	37	32.62
600362	11	176	17.8	24.5	8	4.5	45	34.26
600363	12	186	19.4	26.5	8.5	4.7	55	36.23
600364	13	199	20.4	29.5	8.5	5.2	68	38.85
600365	14	210	22	31.5	9	5.2	82	39.67
600366	15	222	23.2	33.5	9.5	5.7	96	42.62
600367	16	234	24.8	36	10.5	6.2	121	43.44
600368	17	245	26.1	38	10.5	6.7	144	46.39
600369	18	257	27.7	40	11	7.2	165	49.34
600370	19	268	29.3	42	12	7.2	186	52.79
600371	20	280	31	44	12.5	7.7	225	56.07
600372	21	291	32.6	45.5	13	8.2	251	60.00
600373	22	303	34.1	46.5	13	8.2	266	64.92
600374	23	314	35.7	50.5	13	8.2	300	73.28
600375	24	330	37.3	52.5	14	8.5	382	75.74
600376	25	337	39	54.5	14.5	8.5	377	84.26
600377	26	349	40.1	56	15	8.5	422	86.89
600378	27	360	41.6	57.5	15	9	453	95.90
600379	28	373	43.2	59.5	15.5	9	532	103.93
600380	29	383	44.9	61.5	16	9.5	567	112.13
600381	30	395	46.5	63.5	16	10	632	118.69
600382	32	416	49	68	16.5	10.5	719	128.03
607019	35	500	53.5	78.8	20	13.6	1405	207.70
602601	36	500	53.5	78.8	20	13.6	1415	216.23
605838	38	515	58	82.8	20.5	14.1	1310	233.77
602602	41	540	62	86.8	21	14.6	1984	285.57
618514	46	560	69	94	23	16	2445	462.13
618517	50	580	75	103	24	17	1955	533.77
616752	55	600	83	112	26	18	3395	652.13
616753	60	620	91	120	28	20	4120	842.46
616754	65	640	100	130	30	21	5205	1398.85
616755	70	660	108	140	32	23	5995	1544.43
616756	75	680	116	150	34	24	6995	1754.10
616757	80	700	124	160	36	26	8595	2050.00

Barcode	⊖	L	B2	B1	A2	A1	📦	🔩
618491	1/4"	119	10.4	14.5	5	3.5	14	25.90
618492	5/16"	142	13.2	18.5	6.9	3.9	23	26.56
618493	3/8"	153	14.3	21	7.3	4	27	32.62
618494	7/16"	176	17.8	24.5	8	4.5	45	34.26
618495	1/2"	199	20.4	29.5	8.5	5.2	68	38.85
618496	9/16"	211	22	31.5	9	5.2	82	39.67
618497	5/8"	234	24.8	36	10.5	6.2	121	43.44
618498	11/16"	245	26.1	38	10.5	6.7	144	49.34
618499	3/4"	268	29.3	42	12	7.2	186	52.79
618500	13/16"	291	32.6	45.5	13	8.2	251	60.00
618501	7/8"	303	34.1	46.5	13	8.2	266	64.92
618502	15/16"	330	37.3	52.5	14	8.5	382	75.74
618503	1"	337	39	54.5	14.5	8.5	377	84.26
618504	1.1/16"	360	41.6	57.5	15	9	453	95.90
618505	1.1/8"	372	43.2	59.5	15.5	9	532	103.93
618506	1.1/4"	417	49	68	16.5	10.5	719	118.69
618507	1.5/16"	417	49	68	16.5	10.5	732	128.03
618508	1.3/8"	500	53.5	78.8	20	13.6	1425	272.30
618509	1.7/16"	500	53.5	78.8	20	13.6	1395	272.30
618510	1.1/2"	500	53.5	78.8	20	13.6	1335	272.30
618511	1.5/8"	540	62	86.8	21	14.6	2000	352.79
618512	1.11/16"	540	62	86.8	21	14.6	1960	352.79
618513	1.3/4"	560	69	94	23	16	2435	479.84
618515	1.13/16"	560	69	94	23	16	2495	479.84
618516	1.7/8"	560	69	94	23	16	2445	479.84
618518	2"	580	75	103	24	17	2985	539.84

120/1CB

Set de chei combinate lungi in cutie de carton



UNIOR Premium

Barcode	📦	🔩	🔩
600383	6 - 22 / 17	1930	705.74
🔩 120/1	(6, 7, 8, 9, 10, 11, 12, 13, 14, 15, 16, 17, 18, 19, 20, 21, 22)		
600384	6 - 32 / 26	6200	1584.26
🔩 120/1	(6, 7, 8, 9, 10, 11, 12, 13, 14, 15, 16, 17, 18, 19, 20, 21, 22, 23, 24, 25, 26, 27, 28, 29, 30, 32)		
611019	8 - 22 / 10	1105	414.92
🔩 120/1	(8, 10, 11, 12, 13, 14, 15, 17, 19, 22)		
611020	10 - 30 / 12	2611	678.36
🔩 120/1	(10, 11, 12, 13, 14, 15, 17, 19, 22, 24, 27, 30)		
619398	1/4" - 1.1/4" / 16	3720	946.23
🔩 120/1	(1/4", 5/16", 3/8", 7/16", 1/2", 9/16", 5/8", 11/16", 3/4", 13/16", 7/8", 15/16", 1", 1.1/16", 1.1/8", 1.1/4")		



120/1CS

Set de chei combinate lungi in cutie de carton



UNIOR Premium

Barcode	📦	🔩	🔩
603709	8 - 19 / 8	770	303.28
🔩 120/1	(8, 9, 10, 12, 13, 14, 17, 19)		

120/1MS

Set de chei combinate lungi cu suport metalic



UNIOR Premium

Barcode	📦	🔩	🔩
605537	6 - 22 / 17	2765	790.16
🔩 120/1	(6, 7, 8, 9, 10, 11, 12, 13, 14, 15, 16, 17, 18, 19, 20, 21, 22), 977/2 (6 - 22/17)		

120/1CT

Set de chei combinate lungi in husa textila



UNIOR Premium

Barcode	📦	🔩	🔩
615475	8 - 22 / 8	1050	476.56
🔩 120/1	(8, 10, 11, 13, 15, 17, 19, 22), CT129 (470x330)		

125/1

Cheie combinata, varianta scurta

- cheia este forjata din otel premium crom-vanadiu
- cheia se remarcă prin rezistența excepțională, durabilitatea și protecția suprafeței, care oferă utilizatorului o utilizare fiabilă și de lungă durată. Este o soluție completă pentru înșurubarea suruburilor și piulițelor și un instrument indispensabil atât pentru profesioniști, cât și pentru pasionații de bicolaj.
- material: otel premium crom vanadiu
- forjată, calire și revenire totală
- acoperire cromare conform EN12540
- cap lustruit
- în concordanță cu standardul ISO 7738 (numai dimensiunile în mm)
- fabricat în conformitate cu norma ISO 3318/3313A (doar dimensiuni în sistem metric)
- capul cheii sub un unghi de 15°

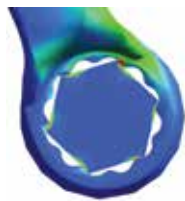
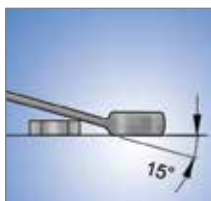

LIFE profile

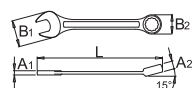

UNIOR Premium

Barcode	⊖	L	B2	B1	A2	A1	📦	🪙
618651	5	84	5.8	12	3	3	9	35.08
618652	5.5	84	5.8	12	3	3	9	35.08
600414	6	100	10.4	14.5	5	3.5	11	23.93
600415	7	109	11.5	16.5	5.8	3.9	15	24.10
600416	8	119	13.2	18.5	6.9	3.9	20	25.08
600417	9	123	14.3	21	7.3	4	25	27.38
600418	10	128	15.9	23	7.5	4.2	29	30.16
600419	11	135	17.8	24.5	8	4.5	35	31.80
600420	12	139	19.4	26.5	8.5	4.7	45	33.28
600421	13	150	20.4	29.5	8.5	5.2	54	34.92
600422	14	160	22	31.5	9	5.2	63	36.23
600423	15	170	23.2	33.5	9.5	5.7	78	38.85
600424	16	180	24.8	36	10.5	6.2	95	39.84
600425	17	190	26.1	38	10.5	6.7	121	42.62
600426	18	200	27.7	40	11	7.2	135	45.57
600427	19	210	29.3	42	12	7.2	157	48.52
600428	20	220	31	44	12.5	7.7	186	51.48
600429	21	230	32.6	45.5	13	8.2	198	55.41
600430	22	247	34.1	46.5	13	8.2	230	59.67
602089	23	250	35.7	50.5	13	8.2	254	67.21
602090	24	266	37.3	52.5	14	8.5	300	69.34
602091	25	270	39	54.5	14.5	8.5	330	76.72
602092	26	275	40.1	56	15	8.5	342	79.84
602093	27	292	41.6	57.5	15	9	365	88.52
602094	28	296	43.2	59.5	15.5	9	432	95.25
602095	29	300	44.9	61.5	16	9.5	455	103.28
602096	30	323	46.5	63.5	16	10	522	108.85
602097	32	343	49	68	16.5	10.5	602	118.03
603332	36	400	54.5	79.5	20	13.5	1115	196.23
618566	41	420	62	86.8	21	14.6	1575	320.33
618570	46	440	69	94	23	16	1985	397.54

125/1CB

Set de chei combinate scurte in cutie de carton



UNIOR Premium

Barcode	👤	📦	🪙
600431	6 - 22 / 17	1590	648.69
🔗	125/1 (6, 7, 8, 9, 10, 11, 12, 13, 14, 15, 16, 17, 18, 19, 20, 21, 22)		
602098	6 - 32 / 26	5240	1455.74
🔗	125/1 (6, 7, 8, 9, 10, 11, 12, 13, 14, 15, 16, 17, 18, 9, 20, 21, 22, 23, 24, 25, 26, 27, 28, 29, 30, 32)		
611021	8 - 22 / 10	893	380.98
🔗	125/1 (8, 10, 11, 12, 13, 14, 15, 17, 19, 22)		
611022	10 - 30 / 12	2100	622.62
🔗	125/1 (10, 11, 12, 13, 14, 15, 17, 19, 22, 24, 27, 30)		

125/1CT

Set de chei combinate scurte in husa textila



UNIOR Premium

Barcode	👤	📦	🪙
625675	6 - 32 / 26	5340	1673.61
🔗	125/1 (6, 7, 8, 9, 10, 11, 12, 13, 14, 15, 16, 17, 18, 19, 20, 21, 22, 23, 24, 25, 26, 27, 28, 29, 30, 32), CT110 (430 x 275)		

125/1CS

Set de chei combinate scurte in cutie de carton



UNIOR Premium

Barcode	👤	📦	🪙
603711	8 - 19 / 8	650	278.20
🔗	125/1 (8, 9, 10, 12, 13, 14, 17, 19)		

125/1CT

Set de chei combinate scurte in husa textila



UNIOR

Barcode	👤	📦	🪙
615478	8 - 22 / 8	851	427.21
🔗	125/1 (8, 10, 11, 13, 15, 17, 19, 22), CT110 (430x275)		

125/1MS

Set de chei combinate scurte cu suport metalic



UNIOR

Barcode	👤	📦	🪙
605539	6 - 22 / 17	2200	733.11
🔗	125/1 (6, 7, 8, 9, 10, 11, 12, 13, 14, 15, 16, 17, 18, 19, 19, 20, 21, 22), 977/3		

IBEX

Cheie combinata rapida



Permite operarea 3 ori mai rapida in comparatie cu cheia combinata standard.



100% pozitionare a cheii



3 suprafete de asezare pentru o forta mai mare.

129/1

Cheie combinata, varianta scurta

- cheia este forjata din otel premium crom-vanadiu
- cheia se remarcă prin rezistența excepțională, durabilitatea și protecția suprafeței, care oferă utilizatorului o utilizare fiabilă și de lungă durată
- este o soluție completă pentru înșurubarea suruburilor și piulițelor și un instrument indispensabil atât pentru profesioniști, cât și pentru pasionații de bricolaj
- datorită formei sale inovatoare, capatul deschis acționează ca un clichet, ceea ce reduce și mai mult timpul de înșurubare.
- material: crom vanadiu
- forjată, calire și revenire totală
- acoperire cromare conform ISO 1456:2009
- capete polizate
- partea înelară cu profil de protecție

Avantaje:

- forța acționează pe flanc pentru a nu deforma interiorul unghiului
- 3 suprafețe conductoare pentru o mai mare forță
- poziționare 100% a cheii
- rotirea cheii fără scoate aceasta

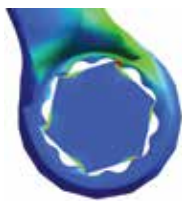
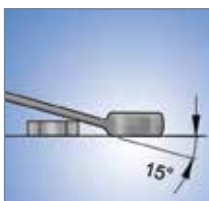

LIFE profile

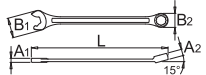

UNIOR Premium

Barcode	⊖	L	B2	B1	A2	A1	📦	🔩	Price
611762	8	140	13.2	18.5	6.9	3.9	22	28.69	
611763	10	160	15.9	23	7.5	4.2	37	34.92	
611764	11	174	17.8	24.5	8	4.5	43	36.72	
611765	12	183	19.4	26.5	8.5	4.7	54	39.02	
611766	13	196	20.4	29.5	8.5	5.2	63	41.64	
611767	14	206	22	31.5	9	5.2	75	42.79	
611768	15	217	23.2	33.5	9.5	5.7	93	45.90	
611769	16	227	24.8	36	10.5	6.2	114	46.56	
611770	17	238	26.1	38	10.5	6.7	131	49.67	
611930	18	250	28	40	11	7.2	155	53.11	
611771	19	261	29.3	42	12	7.2	173	57.54	
611772	22	296	34.1	46.5	13	8.2	258	69.67	
611773	24	321	37.3	52.5	14	8.5	321	81.31	

129/1CS

Set de chei combinate IBEX in cutie de carton



UNIOR

Barcode	👤	📦	🔩	Price
611775	8 - 19 / 8	793	340.16	

🔩 129/1 (8, 10, 12, 13, 14, 15, 17, 19)

129/1CB

Set de chei combinate IBEX in cutie de carton



UNIOR

Barcode	👤	📦	🔩	Price
611776	8 - 24 / 12	1480	574.59	

🔩 129/1 (8, 10, 11, 12, 13, 14, 15, 16, 17, 19, 22, 24)

CT129

Husa goala

- Dimensiune 470 x 330, pentru articolele 129,120,130,180,202
- fixarea velcro este pentru deschiderea și închiderea ușoară
- curea de închidere nu este necesară



UNIOR

Barcode	A	B	📦	🔩	Price
615464	470	330	150	137.70	

250C

Cheie inelara simpla cotita

- material: crom vanadiu
- executie in conformitate cu standardul DIN ISO 691



WGB THE WERKZEUG

Barcode	⊖	L	📦	🔩	Price
2502403	24	179	390	231.00	
2502703	27	190	466	276.53	
2503003	30	200	514	316.23	
2503203	32	235	710	369.59	
2503603	36	244	786	443.57	
2504103	41	265	916	527.10	
2504603	46	280	1188	622.99	
2505003	50	289	1390	694.06	
2505503	55	300	1496	940.02	
2506003	60	345	2250	1251.24	
2506503	65	355	2600	1491.38	
2507003	70	364	2800	1491.38	
2507503	75	370	3800	1889.24	
2508003	80	387	3850	2195.86	



178/2

Cheie inelara simpla cotita

- material: crom vanadiu
- forjată, calire și revenire totală
- acoperire cromare conform EN12540

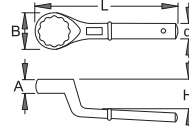

UNIOR Premium

Barcode	⊖	A	B	d	H	L	📦	🔩	Price
620821	24	17	42	18.5	30	180	481	136.39	
620822	27	17	42	18.5	30	180	456	150.49	
620823	30	17	42	18.5	30	180	454	164.10	
620824	32	18	50	20.5	35	235	733	182.30	
620825	36	18	50	20.5	35	235	686	225.41	
620826	41	18	55	20.5	35	235	712	240.16	
620827	46	22	70	23.5	40	265	1208	269.51	
620828	50	22	70	23.5	40	265	1218	316.72	
620829	55	22	75	23.5	40	265	1156	351.97	
620830	60	30	94	29.5	50	345	2512	491.48	
620831	65	30	94	29.5	50	345	2582	725.90	
620835	85	40	125	29.5	59	385	3741	1212.95	
620836	90	45	140	29.5	63	410	3941	1556.72	



178.1/2

Maner de antrenare pentru 178/2

- material: crom molibden
- acoperire cromare conform EN12540



UNIOR Premium

Barcode	↙	D	d	L	📦	🔩
620840	24 - 30	25	19	460	744	145.74
620841	32 - 41	27	21	610	1049	204.92
620842	46 - 55	30	24	760	1509	266.39
620843	60 - 95	37	30	860	2476	359.51

260C

Maner de antrenare pentru 250C

- material: crom vanadiu
- acoperire: cromare



WGB THE WERKZEUG

Barcode	↙	Nr	L	📦	🔩
2600013	22 - 30	1	460	602	203.15
2600023	32 - 41	2	610	920	271.48
2600033	46 - 55	3	760	2150	423.36
2600043	60 - 105	4	860	2850	586.09



280

Cheie inelara simpla dreapta DIN 3111

- material: OLC
- forjata, calire si revenire totala
- executie in conformitate cu standardul DIN 3111



WGB THE WERKZEUG

Barcode	🔩	L	📦	🔩
2803604	36	292	479	485.86
2804604	46	362	919	708.70
2805004	50	388	1188	853.43
2805504	55	441	1628	972.53
2806004	60	473	1764	1194.32
2806504	65	508	2200	1457.98



179/2

Chei inelara dublu cotite pentru schele

- material: crom vanadiu
- forjare, calire si intarire totala
- acoperire cromare conform EN12540
- acoperire prin cromare

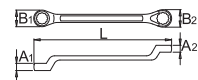

UNIOR

Barcode	🔩	L	B1	B2	A1	A2	📦	🔩
605042	21 x 22	316	34	35	17	17	657	111.80

180/1

Cheie inelara dublu cotita DIN 838

- cheia este forjata din otel premium crom-vanadiu
- cheia se remarcă prin rezistența excepțională, durabilitatea și protecția suprafeței, care oferă utilizatorului o utilizare fiabilă și de lungă durată
- este o soluție completă pentru înșurubarea șuruburilor și piulițelor și un instrument indispensabil atât pentru profesioniști, cât și pentru pasionații de bricolaj.
- material: crom vanadiu
- forjata, calire si revenire totala
- acoperire cromare conform ISO 1456:2009
- capete polizate
- partea inelara cu profil de protecție
- conform standardului ISO 10104 (numai pentru dimensiunile in mm)
- realizat conform standardului DIN 838

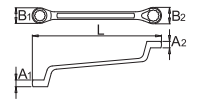

UNIOR Premium

Barcode	🔩	L	B1	B2	A1	A2	📦	🔩
600511	6 x 7	178	10.3	11.8	5.5	6.1	48	32.13
600512	8 x 9	190	14	15.5	6.7	7.3	60	32.79
600513	8 x 10	166	12.9	15.5	6	8	50	35.57
602663	9 x 11	205	15.5	18.5	7.3	8.4	65	39.67
600514	10 x 11	205	17	18.5	7.9	8.4	81	36.23
602997	10 x 12	210	17	20	7.9	9	86	40.16
600516	12 x 13	220	20	21.5	9	9.5	108	38.69
600517	12 x 14	205	17.7	20.3	9	10	95	41.31
600518	13 x 15	235	21.5	24	9.5	10.5	144	43.11
600519	13 x 17	258	21.5	27	9.5	11.5	172	44.43
600520	14 x 15	235	23	24	10	10.5	140	42.30
600521	14 x 17	257	19.8	23.6	10	12	173	47.05
600522	16 x 17	258	26	27	11	11.4	187	44.75
603123	16 x 18	259	22.9	25.4	11	12	205	51.97
600523	17 x 19	270	27	30	11.4	12.4	233	56.89
600524	18 x 19	270	29	30	11.9	12.4	230	52.13
600525	19 x 22	295	30	35	12.4	13.7	308	62.79
600526	20 x 22	295	32	35	12.8	13.7	320	60.98
600527	21 x 23	305	33	37	13.3	14.1	336	67.38
600528	22 x 24	315	35	38	13.7	14.6	368	76.07
600529	24 x 26	325	38	41	14.6	15.4	459	78.20
600530	24 x 27	325	38	42	14.6	15.8	453	83.93
600531	25 x 28	335	40	44	15	16.2	522	85.41
600532	27 x 29	335	42	45	15.8	16.6	589	107.70
600533	27 x 30	360	38.5	42.7	15	16	647	113.11
600534	27 x 32	360	42	49	15.8	17.8	672	103.77
600535	30 x 32	370	46	49	17	17.8	680	101.80
603124	30 x 36	395	43	48	15	18	845	156.39
600536	32 x 36	410	48.2	54.2	17.8	19.4	915	156.39
600537	36 x 41	450	48	56	19	21	945	190.49
602664	41 x 46	472	56	61	21	23	1430	269.34



180/1CB

Set de chei inelare dublu cotite in cutie de carton



UNIOR Premium



600541 6 - 22 / 8 1230 340.00
 180/1 (6 x 7, 8 x 9, 10 x 11, 12 x 13, 14 x 15, 16 x 17, 18 x 19, 20 x 22)

603674 6 - 27 / 10 2020 491.31
 180/1 (6 x 7, 8 x 9, 10 x 11, 12 x 13, 14 x 15, 16 x 17, 18 x 19, 20 x 22, 21 x 23, 24 x 27)

600542 6 - 32 / 12 3275 674.75
 180/1 (6 x 7, 8 x 9, 10 x 11, 12 x 13, 14 x 15, 16 x 17, 18 x 19, 20 x 22, 21 x 23, 24 x 26, 25 x 28, 27 x 32)

600543 6 - 41 / 13 4465 865.25
 180/1 (6 x 7, 8 x 9, 10 x 11, 12 x 13, 14 x 15, 16 x 17, 18 x 19, 20 x 22, 21 x 23, 24 x 26, 25 x 28, 27 x 32, 36 x 41)

180/1CS

Set de chei inelare dublu cotite in cutie de carton



UNIOR Premium



602845 6 - 22 / 8 1320 340.00
 180/1 (6 x 7, 8 x 9, 10 x 11, 12 x 13, 14 x 15, 16 x 17, 18 x 19, 20 x 22)

180/1MS

Set de chei inelare dublu cotite cu suport metalic



UNIOR Premium



605545 6 - 32 / 12 4171 604.43
 180/1 (6 x 7, 8 x 9, 10 x 11, 12 x 13, 14 x 15, 16 x 17, 18 x 19, 20 x 22, 21 x 23, 24 x 26, 25 x 28, 27 x 32), 977/4 (6 - 32/12)

180/1PB

Set de chei inelare dublu cotite in husa de plastic



UNIOR Premium



600544 6 - 22 / 8 1240 768.20
 180/1 (6 x 7, 8 x 9, 10 x 11, 12 x 13, 14 x 15, 16 x 17, 18 x 19, 20 x 22)

290

Cheie inelara dublu cotita DIN 838

- material: crom-vanadiu
- conform DIN 838
- finisare: cromare; ISO 3318; ISO 1085; ISO 10104



WGB THE WERKZEUG

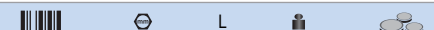

	⊖	L	🔒	🔩
2955603	55 x 60	625	3850	1045.33
2965703	65 x 70	695	5300	1595.30
2975803	75 x 80	775	7000	6510.96

182/2A

Cheie inelara dubla dreapta cu capete drepte DIN 837

- material: crom vanadiu
- forjata, calire si revenire totala
- acoperire cromare conform EN12540
- partea inelara cu profil de protectie
- in concordanta cu standardul DIN 837 (numai pentru dimensiunile in mm)

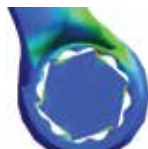

LIFE profile

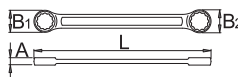

UNIOR Premium

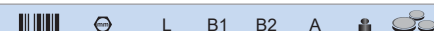

	⊖	L	B1	B2	A	🔒	🔩
612004	6 x 7	97	10	11.3	4.6	11	29.02
612005	8 x 9	112	12.7	14	5.6	19	29.67
612006	10 x 11	132	15.6	16.5	6.6	29	32.79
612007	12 x 13	147	18	19	7.6	44	34.75
612008	14 x 15	162	20.5	21.5	7.6	59	38.20
612009	16 x 17	172	23.2	24.2	8.6	90	40.33
612010	18 x 19	186	25.9	27.4	9.6	112	47.05
612011	20 x 22	206	28.9	31.8	11	161	55.25
612013	24 x 26	258	34.8	37.3	11.5	289	70.66
612015	27 x 29	298	38.3	41.8	13	378	95.41
612016	30 x 32	318	42.7	45.2	13.5	467	91.80

182/2ACB

Set de chei inelare duble drepte in cutie de carton



UNIOR Premium

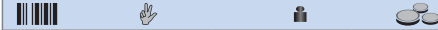

612568 6 - 32 / 11 2275 669.34
 182/2A (6 x 7, 8 x 9, 10 x 11, 12 x 13, 14 x 15, 16 x 17, 18 x 19, 20 x 22, 24 x 26, 27 x 29, 30 x 32)

183/2

Cheie inelara dublu decupata



- material: crom vanadiu
- forjata, calire si revenire totala
- acoperire cromare conform EN12540
- profilul pana la dimensiunea de 12x14 este in 6 puncte, de la 16x18 pana la la 30x32 este in 12 puncte

Utilizare:

- aplicatii: in industrie si ateliere de reparatii specializate in instalatii hidraulice si pneumatice.
- cheia permite lucrul in zone dificile articulate unde folosirea cheilor clasice nu este posibila prin natura muncii (ex: imbinarea cablurilor de otel, conducte hidraulice si de apa, valve etc.)

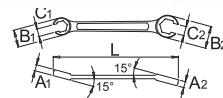

UNIOR Premium

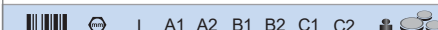

	⊖	L	A1	A2	B1	B2	C1	C2	🔒	🔩
612701	8 x 10	145	7	8.5	18	20	6	7	48	33.11
612702	10 x 11	152	8.5	9	20	22	7	8.5	64	36.89
612703	11 x 13	165	9	11	22	26	8.5	10	88	37.87
612704	12 x 14	178	10	12	24	28	9	11	125	40.16
615147	16 x 18	196	12	12.5	30.5	33.5	13	14	203	42.95
612705	17 x 19	210	13	14	32	35	14	15	204	44.92
612706	19 x 22	233	14	16	35	41	15	17	242	51.64
612707	22 x 24	265	16	17	41	45	17	18	297	67.38
612708	24 x 27	265	17	17	45	48	18	20	367	70.82
612709	30 x 32	285	21	23	50	52	22	24	552	92.46



182/2A

Chei inelare duble drepte cu profil TX

- material: crom vanadiu
- forjata, calire si revenire totala
- acoperire cromare conform EN12540
- 15° unghiul de inclinare al capului inelar asigura o insurubare a piulitei in locurile cu acces dificil



UNIOR Premium

Barcode	Hand	L	B1	B2	A	Weight	Price
612892	E6 x E8	97	10	11.3	4.6	13	37.21
612893	E10 x E12	112	12.7	14	5.6	20	39.84
612894	E14 x E18	137	16.5	21	6.6	38	46.89
612895	E20 x E24	174	23	27.3	8.6	100	60.00



183/2CB

Set de chei inelare dublu decupate in cutie de carton



UNIOR Premium

Barcode	Hand	L	B2	B1	A2	A1	Weight	Price
612985	8 - 22 / 6	824						244.26

183/2 (8 x 10, 10 x 11, 11 x 13, 12 x 14, 17 x 19, 19 x 22)

183/2CB

Set de chei inelare dublu decupate in cutie de carton



UNIOR Premium

Barcode	Hand	L	B2	B1	A2	A1	Weight	Price
612986	8 - 32 / 9	2085						475.08

183/2 (8 x 10, 10 x 11, 11 x 13, 12 x 14, 17 x 19, 19 x 22, 22 x 24, 24 x 27, 30 x 32)

183/2CT

Set de chei inelare dublu decupate in husa



UNIOR Premium

Barcode	Hand	L	B2	B1	A2	A1	Weight	Price
615467	8 - 24 / 6	1065						367.87

183/2 (8 x 10, 11 x 13, 12 x 14, 16 x 18, 17 x 19, 22 x 24), CT252 (360 x 290)

160/2

Cheie combinata cu clichet

- material: crom vanadiu
- tratament termic complet

Avantaje:

- clichet: lucreaza in ambele sensuri, sensul de rotatie se schimba din buton
- 72-dinti, 5° unghi de lucru
- partea poligonala a cheii este dotata de un inel de blocaj destinat impiedicarii alunecarii neasteptate de pe piulita si de a facilita repositionarea pe aceasta.
- permite strangerea piulitei usor si rapid, fara risc de ranire a utilizatorului si repositionarea cheii pe piulita in mod sigur si precis.

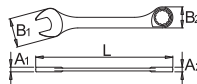

UNIOR Premium

Barcode	Hand	L	B2	B1	A2	A1	Weight	Price
622818	8	134	134	16,7	8,4	4,7	40	72.13
622819	9	158	158	21	8,4	5,5	55	73.61
622820	10	158	158	21	8,4	5,5	60	73.61
622821	11	164	164	23	9,7	6	70	76.23
622822	12	167	167	25	9,7	6,2	80	81.97
622823	13	177	177	27,5	9,7	6,0	96	86.07
622824	14	189	189	29	10,1	7	125	91.80
622825	15	198	198	31,5	11,7	7,2	150	98.85
622826	16	204	204	33	11,7	7,5	165	104.75
622827	17	224	224	34,9	11,7	8	183	111.64
622828	18	245	245	38,9	12	8,8	210	123.28
622829	19	245	245	38,9	19	12	230	129.02
622831	21	280	280	42,6	14,2	9,5	358	169.84
622832	22	280	280	42,6	14,2	9,5	378	169.84
622834	24	310	310	46,5	14,7	10	480	196.89



160/2CS

Set de chei combinate forjate cu clichet in cutie de carton



UNIOR Premium

Barcode	Hand	L	B2	B1	A2	A1	Weight	Price
623709	8 - 19 / 6	820						571.48

160/2 (8, 10, 13, 15, 17, 19)

160/2CB

Set de chei combinate forjate cu clichet in cutie de carton



UNIOR Premium

Barcode	Hand	L	B2	B1	A2	A1	Weight	Price
623080	8 - 24 / 9	2000						1067.38

160/2 (8, 10, 13, 16, 17, 18, 19, 22, 24)

160/2CB

Set de chei combinate forjate cu clichet in cutie de carton



UNIOR Premium

Barcode	Hand	L	B2	B1	A2	A1	Weight	Price
622463	8 - 19 / 7	1800						646.39

160/2 (8, 10, 12, 13, 14, 17, 19)

160/2CT

Set de chei combinate forjate cu clichet in husa textila



UNIOR

Barcode	Hand	L	B2	B1	A2	A1	Weight	Price
627001	8 - 19 / 7	1834						673.11

160/2 (8, 10, 13, 15, 17, 19)



161/2

Cheie combinata cu clichet articulata

- material: crom vanadiu
- tratament termic complet

Avantaje:

- clichet: lucreaza in ambele sensuri, sensul de rotatie se schimba din buton
- 72-dinti, 5° unghi de lucru
- partea poligonala a cheii este dotata de un inel de blocaj destinat impiedicarii alunecarii neasteptate de pe piulita si de a facilita repositionarea pe aceasta.
- permite strangerea piulitei usor si rapid, fara risc de ranire a utilizatorului si repositionarea cheii pe piulita in mod sigur si precis.

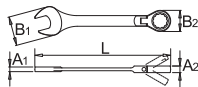

UNIOR Premium

Barcode	⊖	L	B2	B1	A2	A1	📦	🔩
622837	6	136	17,4	16,9	8,4	4,9	50	103.93
622839	8	136	17,4	16,9	8,4	4,9	50	100.00
622841	10	160	20,9	20,8	8,4	3,8	72	105.90
622842	11	177,5	23,4	25,1	9,7	6,2	95	105.90
622843	12	177,5	23,4	25,1	9,7	6,2	95	115.08
622844	13	187,3	24,9	27,2	9,7	6,4	124	119.67
622845	14	194,7	27,4	29,3	10,1	7	144	123.28
622846	15	218	30,4	33	11,7	7,4	207	136.07
622847	16	218	30,4	33	11,7	7,4	207	136.07
622848	17	234,8	31,9	35,2	11,7	8,2	236	160.82
622849	18	251,3	34,5	39,4	12	9	290	160.82
622850	19	251,3	34,5	39,4	12	9	280	161.64



Fara inel de oprire



Partea poligonala a cheii este dotata de un inel de blocaj destinat impiedicarii alunecarii neasteptate de pe piulita si de a facilita repositionarea pe aceasta.



Clichet: functioneaza in ambele sensuri, sensul de rotatie poate fi schimbat cu butonul.



Permite lucrul cu capul poligonol inclinat pana la max. 90°

161/2CB

Set de chei combinate forjate articulate cu clichet in cutie de carton



UNIOR Premium

Barcode	👉	📦	🔩
623081	8 - 19 / 5	1360	648.03
161/2 (8, 10, 13, 17, 19)			

161/2CS

Set de chei articulate combinate forjate cu clichet, in cutie de carton



UNIOR Premium

Barcode	👉	📦	🔩
623710	8 - 19 / 6	1015	784.10
161/2 (8, 10, 13, 15, 17, 19)			

161/2CT

Set de chei combinate forjate articulate cu clichet in husa textila



UNIOR Premium

Barcode	👉	📦	🔩
627002	8 - 19 / 6	975	855.74
161/2 ((8, 10, 11, 13, 17, 19), CT252 ())			



170/2CB

Set de chei inelare duble forjate cu clichet in cutie de carton



UNIOR

Barcode	👉	📦	🔩
623082	6 - 19 / 6	800	880.49
170/2 (6 x 8, 10 x 11, 12 x 13, 14 x 15, 16 x 18, 17 x 19)			

170/2

Cheii inelare duble forjate cu clichet

- material: crom vanadiu
- tratament termic complet

Avantaje:

- clichet: lucreaza in ambele sensuri, sensul de rotatie se schimba din buton
- 72-dinti, 5° unghi de lucru
- partea poligonala a cheii este dotata de un inel de blocaj destinat impiedicarii alunecarii neasteptate de pe piulita si de a facilita repositionarea pe aceasta.
- permite strangerea piulitei usor si rapid, fara risc de ranire a utilizatorului si repositionarea cheii pe piulita in mod sigur si precis.

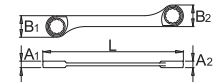

UNIOR Premium

Barcode	⊖	L	B2	B1	A2	A1	📦	🔩
622851	6 x 8	114,2	17,4	17,4	8,4	8,4	40	123.28
622852	8 x 9	130,4	20,9	17,4	8,4	8,4	55	123.28
622853	8 x 10	130,4	20,9	17,4	8,4	8,4	55	123.28
622854	10 x 11	144,4	22,9	20,9	9,7	8,4	72	124.43
622856	12 x 13	166	24,9	23,4	9,7	9,7	97	133.77
622857	14 x 15	181,4	30,4	27,4	11,7	10,1	142	152.30
622858	16 x 18	205,9	33,9	30,4	12	11,7	198	170.98
622859	17 x 19	224,4	34,4	31,9	12	11,7	211	175.57

CT252

Husa goala

- pentru articol 160,161,170,183



UNIOR

Barcode	A	B	📦	🔩
615155	360	290	98	101.80

184/7

Cheie inelara de soc DIN 7444

- material: otel carbon de scule
- forjata, calire si revenire totala
- acoperire: uleiere anticoroziva
- in concordanta cu standardul DIN 7444 (numai dimensiunile in mm)

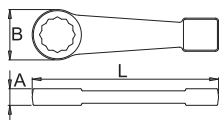

UNIOR Premium

Barcode	⊖	L	B1	B2	⊞	⊞
620494	24	180	48.6	16	534	113.77
620495	27	180	48.6	16	514	127.38
620496	30	180	48.6	16	488	150.82
620497	32	190	58.4	18	739	160.82
620498	36	190	58.4	18	694	203.11
620499	41	235	74	22	1425	264.26
620500	46	235	74	22	1360	293.93
620501	50	235	74	22	1272	330.00
620502	55	275	97.6	27	2800	370.49
620503	60	275	97.6	27	2710	400.00
620504	65	275	97.6	27	2580	517.70
620505	70	335	117	35	4685	590.16
620506	75	335	117	35	4570	620.82
620507	80	350	124	35	4305	851.31
620508	85	358	130	39	4220	1037.70
620509	90	395	144	41	5335	1255.08
620510	95	395	144	39	5090	1401.48
620511	100	420	155	43	6800	1530.33
620512	105	420	155	42	5930	2824.59
620513	110	451	170	46	8200	2877.38
620515	120	500	190	52	11400	3991.48
620516	125	500	190	53	10800	4230.98
620518	135	520	200	60	13800	5848.52
620519	140	574	220	61	17000	6014.10
620520	145	574	220	60	16600	8087.05
620521	150	574	220	61	17000	8558.52
620522	1.1/16"	180	49	16	512	133.77
620523	1.1/8"	180	49	16	511	133.77
620525	1.1/4"	190	58	18	740	168.85
620526	1.5/16"	190	58	18	708	213.11
620527	1.3/8"	190	58	18	700	213.11
620528	1.7/16"	190	58	18	687	213.11
620529	1.1/2"	235	74	22	1470	277.54
620530	1.5/8"	235	74	22	1425	277.54
620531	1.11/16"	235	74	22	1440	277.54
620533	1.13/16"	235	74	22	1360	308.52
620534	1.7/8"	235	74	22	1350	346.56
620535	2"	235	74	22	1335	346.56
620536	2.1/16"	275	98	27	2831	388.85
620537	2.1/8"	275	98	27	2840	388.85
620538	2.3/16"	275	98	27	2800	388.85
620539	2.1/4"	275	98	27	2730	420.00
620541	2.3/8"	275	98	27	2710	420.00
620542	2.1/2"	275	98	27	2580	502.30
620543	2.9/16"	275	98	27	2580	519.02
620544	2.5/8"	335	117	28.5	4685	612.13
620545	2.3/4"	335	117	35	4685	646.72
620546	2.15/16"	335	117	35	4520	747.21
620547	3"	335	117	35	4570	770.49
620548	3.1/8"	350	124	35	4305	1074.26



7184

Cheie inelara de soc DIN 7444

- material: otel carbon de scule
- forjata, calire si revenire totala
- acoperire: brunare
- in concordanta cu standardul DIN 7444

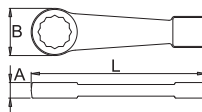

KRONUS Professional Quality

Barcode	⊖	L	B	A	⊞	⊞
700659	24	180	48.6	16	534	44.76
700660	27	180	48.6	16	514	47.12
700661	30	180	48.6	16	488	54.19
700662	32	190	58.4	18	739	59.37
700663	36	190	58.4	18	694	71.62
700664	41	235	74	22	1425	90.71
700665	46	235	74	22	1360	110.97
700666	50	235	74	22	1335	135.22
700667	55	275	97.6	27	2800	178.84
700668	60	275	97.6	27	2710	211.35
900501	65	275	97.6	27	2580	285.64
900502	70	330	108	33	4685	393.27
902277	75	335	117	35	4570	493.18
902278	80	350	124	35	4305	628.92



270SG

Cheie inelara de soc DIN 7444

- material: otel carbon de scule
- forjata, calire si revenire totala
- acoperire: brunare
- in concordanta cu standardul DIN 7444

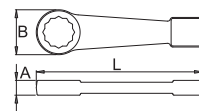

WGB THE WERKZEUG

Barcode	⊖	L	⊞	⊞
2711007	110	450	7750	4479.02
2711507	115	447	7450	4888.03
2712007	120	475	12150	5262.30
2712507	125	480	9550	10049.51
2713507	135	520	12100	11422.79
2714007	140	520	12250	13298.85
2714507	145	580	18100	18595.29
2715007	150	580	18200	19845.31





118/7

Chei fixe de soc DIN 133

- material: otel carbon de scule
- forjată, calire și revenire totală
- acoperire: ulei de anticorozivă
- în concordanță cu standardul DIN 133

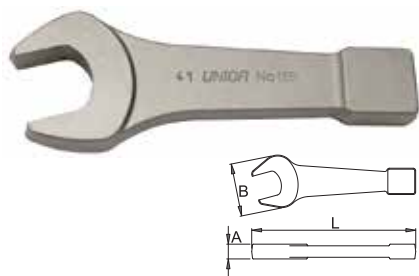

UNIOR Premium

Barcode	⊖	L	B1	B2	🔩	🔩
620466	24	170	56	15	489	96.56
620467	27	170	56	15	477	96.56
620468	30	200	70	18	863	126.56
620469	32	200	70	18	863	133.44
620470	36	200	70	18	834	173.28
620471	41	240	88	20	1490	212.30
620472	46	240	88	20	1450	289.67
620473	50	265	102	20	1790	326.89
620474	55	305	112	24	2700	381.31
620475	60	305	112	24	2615	424.92
620476	65	335	123	27	3645	545.25
620477	70	370	143	30	2200	667.38
620478	75	370	143	30	4865	731.64
620479	80	400	175	33	6450	891.97
620480	85	400	175	33	5775	993.28
620481	90	450	192	38	7620	1312.46
620482	95	450	192	38	9400	1448.85
620485	110	515	235	48	12400	2798.03
620486	115	515	235	52	15800	3567.54
620487	120	535	260	53	20000	3859.67
620488	125	535	260	53	19200	4141.48
620490	135	565	285	53	23400	5507.05
620491	140	635	307	58	28800	5766.07
620492	145	635	307	58	28800	7851.97
620493	150	635	307	58	28200	8484.92



7118

Chei fixe de soc DIN 133

- material: otel carbon de scule
- forjată, calire și revenire totală
- acoperire: brunare
- în concordanță cu standardul DIN 133

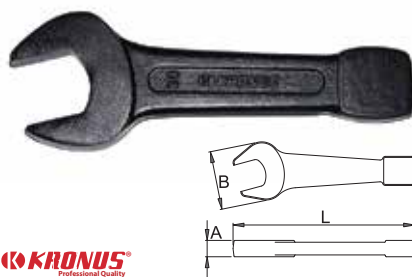

KRONUS Professional Quality

Barcode	⊖	L	B	A	🔩	🔩
700264	24	170	56	15	489	45.47
700265	27	170	56	15	477	56.54
700266	30	200	70	18	863	65.97
700267	32	200	70	18	863	69.51
700268	36	200	70	18	834	85.04
700269	41	240	88	20	1490	109.55
700270	46	240	88	20	1450	143.24
700271	50	265	102	20	1790	169.53
700272	55	305	112	24	2700	206.68
700273	60	305	112	24	2615	215.97
900605	65	335	123	27	3645	355.10
900606	70	370	143	30	3200	465.88
902279	80	400	175	33	6450	542.95
902535	85	400	175	33	5780	633.44

255/2

Chei cu gheara DIN 1810 tip A

- material: crom vanadiu
- capul cheii este tratat în întregime
- acoperire cromare conform EN12540
- conform cu standardul DIN 1810 tip A

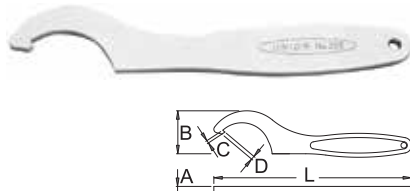

UNIOR Premium

Barcode	⊖	L	C	D	A	B	🔩	🔩
613050	12-14	109	1.2	1.5	3	12	27	28.20
613051	16-20	109	1.5	2	3	12	28	28.20
613052	25-28	136	2	2.5	4	21	56	29.18
613053	30-32	136	2	2.5	4	21	55	29.18
613054	34-36	171	2.5	3	5	28.5	114	39.02
613055	40-42	171	2.5	3	5	28.5	111	39.02
613056	45-50	207	3	3.5	6	37	206	47.54
613057	52-55	207	3	3.5	6	37	209	47.54
613058	58-62	242	3.5	4	7	46	320	62.62
613059	68-75	242	3.5	4	7	46	303	62.62
613060	80-90	281	4	5	8	61	472	84.75
613061	95-100	281	4	5	8	61	436	84.75
613062	110-115	334	4	5	10	81	805	141.15
613063	120-130	334	4	5	10	81	829	141.15



681 B

Chei cu gheara, varianta cu stift DIN 1810 tip B

- conform DIN 1810 B
- acoperire: brunare
- pentru caneluri cu gauri radiale DIN 1816



WGB THE WERKZEUG

Barcode	⊖	L	pin	🔩	🔩
9207921	12-14	110	2	23	63.96
9202231	16-18	110	2.5	22	35.82
9202241	20-22	110	2.5	21	35.82
9202251	25-28	136	3	45	47.95
9202261	30-32	136	4	45	47.95
9202271	34-36	170	4	88	71.64
9202281	40-42	170	4	88	72.20
9202291	45-50	205	5	154	102.44
9202301	52-55	205	5	156	102.44
9202311	58-62	240	5	251	160.47
9202321	68-75	240	6	251	167.86
9202331	80-90	280	6	400	249.15
9202341	95-100	280	8	410	249.15
9202351	110-115	335	8	566	352.54
9202361	120-130	335	8	578	352.54
9202371	135-145	380	8	1000	525.15
9202381	155-165	380	8	1000	551.32
9202391	180-195	470	10	1580	845.50
9202401	205-220	470	10	1580	845.50

255/2F

Chei cu gheara flexibila

- material: crom vanadiu
- capul cheii este tratat în întregime
- acoperire cromare conform EN12540

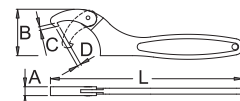

UNIOR Premium

Barcode	⊖	L	B2	B1	A2	A1	🔩	🔩
615027	15-35	140	2.5	2.5	7	25	83	85.08
615028	35-50	201	4	4	10	41.5	196	114.59
615029	50-80	262	5	5	12	68	455	160.33
615030	80-120	320	5.5	5.5	14	86	829	230.49
615031	120-180	418	7.5	9	16	134	1768	328.20



516 B

Cheie cu gheara flexibila, varianta cu stift

- conform DIN 1810 B
- acoperire: brunare
- pentru caneluri cu gauri radiale DIN 1816



WGB THE WERKZEUG

Barcode	Pin	L	pin	Weight	Price
9222851	22 - 35	151	2.9	97	280.57
9222861	35 - 60	175	4	97	297.63
9222871	60 - 90	250	5.5	267	358.84
9222881	95 - 155	290	6	446	520.79
9222721	165 - 230	390	9.5	1200	835.56



255/2CT

Set de chei cu gheara in husa



UNIOR Premium

Barcode	Quantity	Weight	Price
615156	9	3116	721.48

255/2 (30-32, 40-42, 45-50, 52-55, 58-62, 68-75, 80-90, 95-100, 110-115)

193N

Cheie cu maner de plastic in T

- material: tija-crom vanadiu tratata complet
- maner-polipropilena
- placat cu invelis de crom conform EN 12540

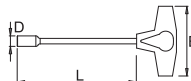

UNIOR Premium

Barcode	Pin	D	L	B	Weight	Price
608283	5.5	8.8	230	88	106	55.74
608284	6	9	230	88	107	55.74
608285	7	11	230	88	112	57.70
608286	8	12	230	88	135	58.36
608287	9	13	230	88	160	59.51
608288	10	14	230	88	161	61.64
608289	11	16	230	88	169	77.38
608290	12	17.5	230	88	196	79.18
608291	13	18	230	88	199	80.49
608292	14	20	230	88	208	83.28
608293	15	22	230	88	212	88.69
608295	17	23	230	88	223	92.62

193NTX

Cheie tubulara cu profil TX interior si maner in T

- material: tija-crom vanadiu tratata complet
- maner-polipropilena
- placat cu invelis de crom conform EN 12540

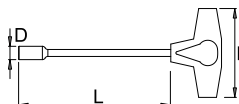

UNIOR Premium

Barcode	Pin	D	L	B	Weight	Price
621376	E 10	12	231	89	157	185.08

196/2

Cheie cu maner in T

- material: crom vanadiu
- capul cheii este tratat in intregime
- acoperire cromare conform EN12540

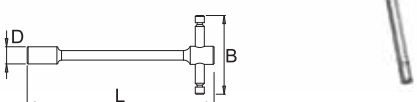

UNIOR Premium

Barcode	Pin	D	B	L	Weight	Price
602077	13	19.2	180	260	307	84.75

202/1

Cheie tubulare dublu articulate

- material: crom vanadiu
- acoperire cromare conform EN12540
- forjata, calire si revenire totala



UNIOR Premium

Barcode	Pin	L	D1	D2	Weight	Price
609132	8 x 9	198	12	13	96	70.49
609133	8 x 10	200.5	12	14.6	82	75.25
609134	10 x 11	214	14.6	16	95	78.20
609135	12 x 13	227	17	18	148	83.28
609136	13 x 17	242	18	23	213	91.15
609137	14 x 15	241	19.5	20.5	211	91.15
609138	16 x 17	255	22	24	295	96.56
609139	18 x 19	273	24.5	26	391	112.46
609141	20 x 22	295	27.5	30	518	131.97



202/1CT

Set de chei tubulare dublu articulate in husa



UNIOR Premium

Barcode	Pin	Weight	Price
615472	8 - 22 / 8	2122	893.11

202/1 (8 x 9, 10 x 11, 12 x 13, 13 x 17, 14 x 15, 16 x 17, 18 x 19, 20 x 22), CT129 (470 x 330)

176

Chei tubulare pipa cu 6 laturi

- material: crom vanadiu
- forjată, calire si revenire totala
- acoperire cromare conform EN12540

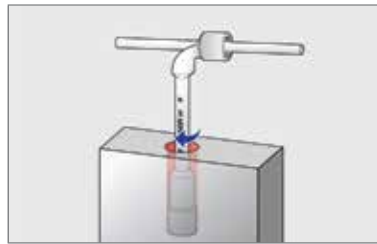
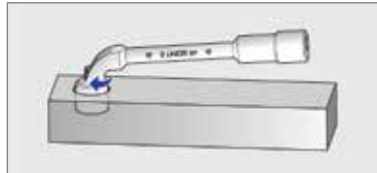
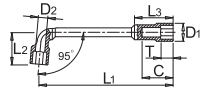

Datorita profilului adanc, cheia se foloseste si pentru chei tubulare si tije filetate.

UNIOR Premium

Barcode	⊕	L	B1	B2	L	B1	B2	B2	🏠	🪙
609102	6	104,5	22	22	11	7	29	5	44	68.85
609103	7	108	25	23	12	8	30,5	5	47	68.85
609104	8	113	26	27	13	10	30	6,5	76	71.48
609105	9	118	27	29	14,5	10	33	7	78	73.28
609106	10	123	31	32	16	11	35	7,5	123	78.85
609107	11	128,5	32	31	17	12	37	7,5	125	84.43
609108	12	135	33	34	18	12	40	8,5	161	90.33
609109	13	143	36,5	40	19	14	47	9	186	92.46
609110	14	149,5	40	41	21	14	48	10,5	226	113.44
609111	15	163	41,5	43	22,5	15	50	11	236	113.44
609112	16	173	46,5	47	24	17	54	13	340	113.44
609113	17	184,5	46,5	49	25	18	56	13	360	132.95
609114	18	198	49	51,5	26,5	19,5	58	13	411	132.95
609115	19	204	52	52,5	28	20,5	62	14	445	135.25
609116	20	207	53,5	54,5	30	21,5	63	14	495	174.10
609117	21	216	57	57,5	30,5	23,5	65	15	487	174.10
609118	22	231	57	58	32	23,5	67	16	590	214.92
609119	23	238	62	64,5	33,5	24,5	74	18	640	214.92
609120	24	249	64,5	68,5	34	25,5	77	18	713	234.75
609121	25	260	67	69,5	36	25,5	79	19,5	703	240.82
609122	26	270,5	68	70	36	27	81	22	876	280.33
609123	27	280	68	71	37	25,5	80	20	867	293.28
609124	28	290,5	70	73,5	38,5	27,5	84	21	1045	306.56
609125	29	298,5	72	78,5	41	28,5	90	22	1140	325.74
609126	30	311	75	80,5	42	28,5	93	23	1257	340.00
609127	32	330,5	79	82,5	45	28,5	95	24	1434	383.61
609128	35	340	90	97,5	48	35,5	108	25	2200	465.25
609129	36	376	80	86	50	30	100	25	2235	478.20

176CB

Trusa de chei tubulare pipa material plin in cutie de carton



UNIOR Premium

Barcode	👤	🏠	🪙
609130	8 - 24 / 16	5230	2070.82
🔑 176 (8, 9, 10, 11, 12, 13, 14, 15, 16, 17, 18, 19, 21, 22, 23, 24)			
609131	8 - 32 / 22	11800	4000.16
🔑 176 (8, 9, 10, 11, 12, 13, 14, 15, 16, 17, 18, 19, 21, 22, 23, 24, 26, 27, 28, 29, 30, 32)			

176CS6

Set de chei pipa in cutie de carton



UNIOR Premium

Barcode	👤	🏠	🪙
620581	8 - 19 / 6	1365	595.25
🔑 176 (8, 10, 11, 13, 17, 19)			

176CS11

Set de chei pipa in cutie de carton



UNIOR Premium

Barcode	👤	🏠	🪙
620582	8 - 24 / 11	3650	1381.64
🔑 176 (8, 10, 11, 12, 13, 16, 17, 18, 19, 22, 24)			

177CB

Trusa de chei tubulare pipa material plin in cutie de carton



UNIOR Premium

Barcode	👤	🏠	🪙
609100	8 - 24 / 16	5230	2070.82
🔑 177 (8, 9, 10, 11, 12, 13, 14, 15, 16, 17, 18, 19, 21, 22, 23, 24)			

177CS6

Set de chei pipa in cutie de carton



UNIOR Premium

Barcode	👤	🏠	🪙
620583	8 - 19 / 6	1365	595.25
🔑 177 (8, 10, 11, 13, 17, 19)			

177CS11

Set de chei pipa in cutie de carton



UNIOR Premium

Barcode	👤	🏠	🪙
620584	8 - 24 / 11	3650	1381.64
🔑 177 (8, 10, 11, 12, 13, 16, 17, 18, 19, 22, 24)			

177

Cheie tubulara pipa cu 12 laturi

- material: crom vanadiu
- forjata, calire si revenire totala
- acoperire cromare conform EN12540

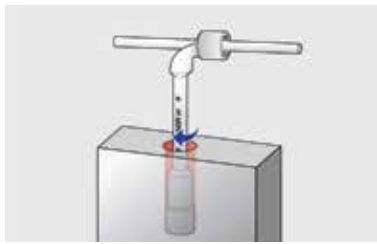
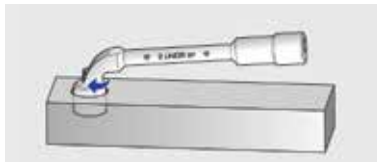
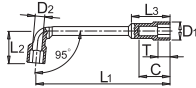

Datorita profilului adanc, cheia se foloseste si pentru chei tubulare si tije filetate.

UNIOR Premium

Barcode	⊖	L	B1	B2	L	B1	B2	B2	⊞	⊞
609083	8	113	26	27	13	10	30	6,5	76	71.48
609084	9	118	27	29	14,5	10	33	7	78	73.28
609085	10	123	31	32	16	11	35	7,5	123	78.85
609086	11	128,5	32	31	17	12	37	7,5	125	84.43
609087	12	135	33	34	18	12	40	8,5	161	90.33
609088	13	143	36,5	40	19	11	47	9	186	92.46
609089	14	149,5	40	41	21	14	48	10,5	226	113.44
609090	15	163	41,5	43	22,5	15	50	11	236	113.44
609091	16	173	46,5	47	24	17	54	13	340	113.44
609092	17	184,5	46,5	49	25	18	56	13	360	132.95
609093	18	198	49	51,5	26,5	19,5	58	13	411	132.95
609094	19	204	52	52,5	28	20,5	62	14	445	135.25
609095	20	207	53,5	54,5	30	21,5	63	14	495	174.10
609096	21	216	57	57,7	30,5	23,5	65	15	487	174.10
609097	22	231	57	58	32	23,5	67	16	590	214.92
609098	23	238	62	64,5	33,5	24,5	74	18	640	214.92
609099	24	249	64,5	68,5	34,5	25,5	77	18	713	234.75

215/2

Cheie tubulara teava DIN 896

- material: crom molibden
- capul cheii este tratat in intregime
- acoperire cromare conform EN12540
- in conformitate cu standardul DIN 896

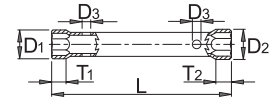

UNIOR Premium

Barcode	⊖	L	D1	D2	D3	T1	T2	⊞	⊞
600696	6 x 7	105	10	11,2	6,3	8	8	28	25.74
600697	8 x 9	105	12,7	14	6,3	9	9	39	28.36
600698	8 x 10	120	12,8	15	6,3	8	8	64	29.51
600699	10 x 11	120	15,5	16,7	6,3	10	10	64	33.11
600700	12 x 13	140	18,2	19,5	8,5	12	12	104	35.74
600717	13 x 17	150	20	24,6	10,5	13	13	144	41.80
600701	14 x 15	140	21,2	22,3	8,5	14	14	134	38.85
600718	14 x 17	150	21,2	24,6	10,5	13	13	142	41.80
600702	16 x 17	150	23,5	24,6	10,5	15	15	158	41.80
600719	17 x 19	160	24,6	27	12,5	16	16	183	50.00
600703	18 x 19	155	25,8	27	12,5	16	16	184	50.00
605044	19 x 22	170	27	31,4	12,5	18	18	266	56.56
607960	19 x 24	160	27	33,7	14,5	20	20	230	55.41
600705	20 x 22	165	29	31,4	12,5	18	18	269	56.56
600706	21 x 23	165	30,3	32,5	14,5	20	20	282	63.44
607962	22 x 24	160	31,4	33,7	14,5	20	20	299	68.52
600707	24 x 26	185	33,7	36	14,5	22	22	356	68.52
600723	24 x 27	190	33,7	37,2	14,5	22	22	374	68.52
600708	25 x 28	200	34,8	38,3	16,5	24	24	432	86.39
600709	27 x 32	200	38,1	44	16,5	27	27	536	95.08
602557	30 x 32	200	41,6	44	16,5	27	27	585	95.08
603128	30 x 36	215	42,6	49,6	18,5	28	28	730	117.54
618575	41 x 46	235	52	57	22	34	34	1555	258.20
618577	50 x 55	235	63	68	21	39	75	2030	333.93

215/2CB

Trusa de chei tubulare in cutie de carton



UNIOR Premium

Barcode	⊖	L	⊞	⊞
600710	6 - 32 / 14		3241	695.25

215/2 (6 x 7, 8 x 9, 10 x 11, 12 x 13, 14 x 15, 16 x 17, 18 x 19, 20 x 22, 21 x 23, 24 x 26, 25 x 28, 27 x 32),
215/1/2 (6 - 17, 18 - 41)

217/2

Chei tubulare pipa din teava

- material: crom molibden
- capul cheii este tratat in intregime
- acoperire cromare conform EN12540

Utilizare

- aplicatii: in industrie si ateliere de reparatii pentru lucrul in locuri greu accesibile
- datorita formei locasului se asigura imbracarea etansa a elementelor de ansamblare cu filete lungi

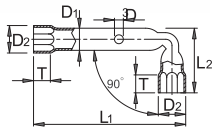

UNIOR Premium

Barcode	⊖	L1	L2	D1	D2	D3	T	⊞	⊞
617053	5.5	98	25	7	8,5	4,3	7	18	23.61
617054	6	103	26	9	10	5,3	8	35	23.93
617057	9	110	34	11	13,5	6,3	9	54	28.03
617059	11	120	40	13	16,7	6,3	10	81	30.82
617060	12	135	46	16	18,2	8,5	12	123	37.21
617061	13	133	46	16	19,5	8,5	12	126	37.87
617063	15	135	51	18	22,3	8,5	14	163	43.77
617065	17	140	56	20	24,6	10,5	15	197	49.51
617066	18	149	65	22	25,8	12,5	16	234	55.41
617070	22	159	71	25	31,4	12,5	20	353	67.54



215.1/2

Tija de antrenare chei tubulare teava

- material: otel carbon de scule
- capul cheii este tratat in intregime
- acoperire cromare conform EN12540



UNIOR

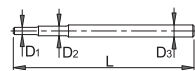

Barcode	⊖	L	D1	D2	D3	⊞	⊞
600745	6 - 17	230	6	8	10	137	18.52
600747	18 - 32	330	12	14	16	493	53.28
624342	36 - 55	500		18	20	1202	89.18

210/2

Cheie pentru roti

- material: crom vanadiu
- forjată, calire și revenire totală
- acoperire cromare conform EN12540

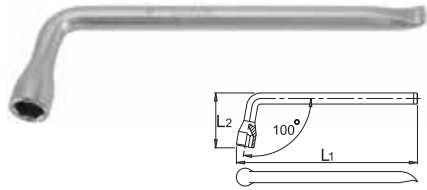

UNIOR Premium

Barcode	⊖	L1	L2	⊞	⊞
600782	17	255	27	476	80.82
600783	19	285	29.5	541	93.11

185/2

Cheie de bujii

- material: oțel carbon de scule
- acoperire cromare conform EN12540

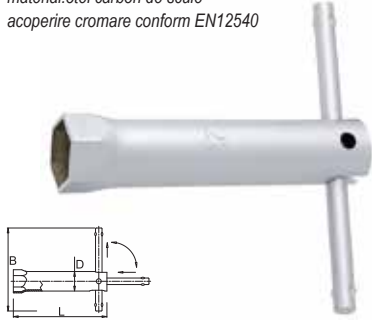

UNIOR Premium

Barcode	⊖	D	L	B	⊞	⊞
600771	16	19	145	120	182	34.26
607956	19	22	115	120	199	35.74
600772	21	24	115	120	177	35.74
600773	21	24	180	120	248	38.52

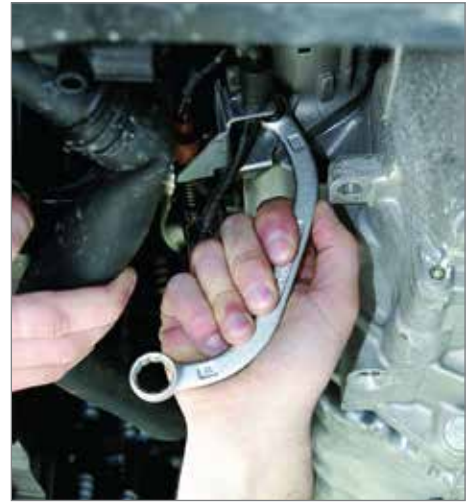

200/2CB

Set de chei inelare semiluna in cutie de carton



UNIOR Premium

Barcode	⊞	⊞	⊞	⊞
600677	11 - 22 / 5	605	317.21	
200/2 (11 x 13, 13 x 17, 14 x 17, 15 x 16, 19 x 22)				

175/2

Cheie schimbă ulei la cutia de viteze

- material: crom vanadiu
- capul cheii este tratat în întregime
- acoperire cromare conform EN12540



UNIOR Premium

Barcode	■	L1	L2	D	⊞	⊞
605112	8 x 10	203	169	10	305	47.21

205/2

Cheie filtru de ulei

- material: crom vanadiu
- banda din inel de cauciuc
- forjată, calire și revenire totală
- acoperire cromare conform EN12540

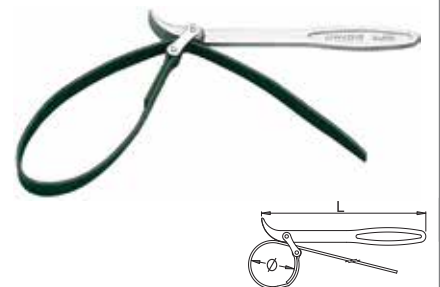

UNIOR

Barcode	L	Ø1	Ø2	⊞	⊞
601024	220	60	140	225	95.08

212/2

Chei în T pentru roti

- material: crom vanadiu
- forjată, calire și revenire totală
- acoperire cromare conform EN12540
- în concordanță cu ISO DIN 3112

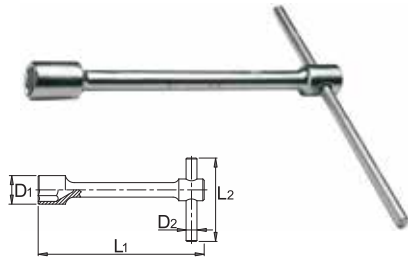

UNIOR Premium

Barcode	⊖	L1	D1	L2	D2	⊞	⊞
600789	27	355	38.5	400	20	2220	212.79
600790	30	425	42.5	400	20	2450	234.26
600791	32	430	48	400	20	2815	277.21



200/2

Chei inelare semiluna

- material: crom vanadiu
- forjată, calire și revenire totală
- acoperire cromare conform EN12540

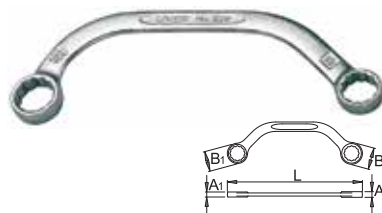

UNIOR Premium

Barcode	⊖	L	B1	B2	A1	A2	⊞	⊞
600671	11 x 13	150	16.5	19	7	8.5	54	54.43
600672	13 x 17	185	19.2	24.2	8.7	10.3	99	61.31
600673	14 x 17	185	20.5	24.2	8.7	10.3	104	61.31
600674	15 x 16	185	21.6	23.6	8.7	10.3	104	61.31
600676	19 x 22	230	27.2	31.8	10	11.5	178	78.69



213/6

Cheie cruce pentru roti

- material: crom vanadiu
- forjată, calire și revenire totală
- vopsite
- în conformitate cu standardul ISO 6788 (numai dimensiuni în mm)

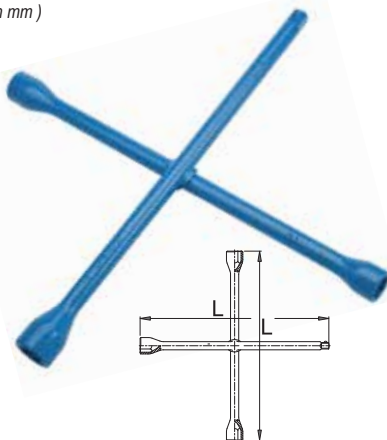

UNIOR Premium

Barcode	⊖	⊖	⊖	⊖	L	⊞	⊞
600811	17	19	22	1/2"	370	1430	238.52
600809	17	19	21	23	370	1511	212.46
600812	17	19	22	24	370	1500	212.46
600813	24	27	30	3/4"	700	4400	481.97
600814	24	27	30	32	700	4600	481.97

205.1

Curea pentru art. 205/2

- banda din invelis de cauciuc



UNIOR

602841	62	61.48

206/2

Cheie cu lant

- material: crom vanadiu
- forjata, calire si revenire totala
- acoperire cromare conform EN12540



UNIOR Premium

	L	Ø ₁	Ø ₂		
601025	220	60	140	330	183.44

206.1

Lant pentru art. 206

- P = 12,7 mm (1/2") (pasul lantului)
 h2 = 9,5 mm (latimea eclisei)
 L = 9,5^{±0,1} mm (latimea lantului)
 T = t = 1,0 mm (grosimea ecliselor)
 d2 = 3,6 mm (diametrul boltului)
 d1 = 7,7 mm (diametrul rolei)
 b1 = 3,2 mm (lungimea rolei)

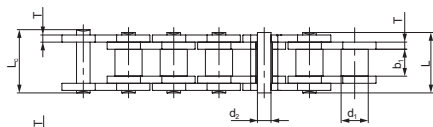
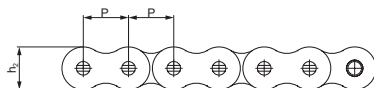

UNIOR

	L		
620938	500	150	35.90

Lollipop

Cheia multifunctionala cu curea 6-100 mm Lollipop

- fara urme sau zgarieturi
- pentru utilizare in casa, garaj, atelier, fabrica, industrie si altele
- produs aprobat de NATO
- cheia multifunctionala Boa este utilizabila pentru cele mai vaste zone industriale din lume
- utilizare: aerospacial, NATO, optica, automobilistica, ingatii, agricultura, marina, hobby, constructii, industria petro-chimica etc.
- oferind o forta uimitoare si o parghie exceptionala, Boa Constrictor va prinde, rasuci, strange si desuruba orice forma sau material fara a zgaria

Lollipop



boa

	L (mm)	L (inch)		
10001	6 - 100	1/4" - 4"	-	20.46



11022/21/ENB

Cheia multifunctionala cu curea 6-100 mm Baby Boa cu maner polipropilena cauciucat

- fara urme sau zgarieturi
- pentru utilizare in casa, garaj, atelier, fabrica, industrie si altele
- produs aprobat de NATO
- cheia multifunctionala Boa este utilizabila pentru cele mai vaste zone industriale din lume
- utilizare: aerospacial, NATO, optica, automobilistica, ingatii, agricultura, marina, hobby, constructii, industria petro-chimica etc.
- oferind o forta uimitoare si o parghie exceptionala, Boa Constrictor va prinde, rasuci, strange si desuruba orice forma sau material fara a zgaria

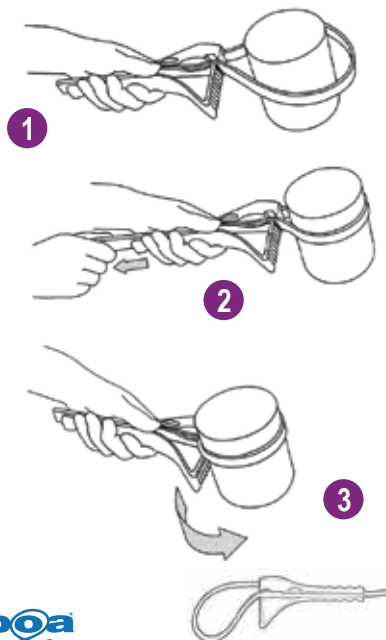

boa

	L (mm)	L (inch)		
11022/21/ENB	6 - 100	1/4" - 4"	-	36.40



14012/07

Set chei multifunctionale cu cureaua 6-100 mm Lollipop + Baby Boa

- fara urme sau zgarieturi
- pentru utilizare in casa, garaj, atelier, fabrica, industrie si altele
- produs aprobat de NATO
- cheia multifunctionala Boa este utilizabila pentru cele mai vaste zone industriale din lume
- utilizare: aerospacial, NATO, optica, automobilistica, irigatii, agricultura, marina, hobby, constructii, industria petro-chimica etc.
- oferind o forta uimitoare si o parghie exceptionala, Boa Constrictor va prinde, rasuci, strange si desuruba orice forma sau material fara a zgaria



14012/07	2	-	48.98
10001 (6-100 mm), 11021/21/ENB (6-100 mm)			

11021/21/ENB

Cheia multifunctionala cu cureaua 6-100 mm Baby Boa cu maner polipropilena

- fara urme sau zgarieturi
- pentru utilizare in casa, garaj, atelier, fabrica, industrie si altele
- produs aprobat de NATO
- cheia multifunctionala Boa este utilizabila pentru cele mai vaste zone industriale din lume
- utilizare: aerospacial, NATO, optica, automobilistica, irigatii, agricultura, marina, hobby, constructii, industria petro-chimica etc.
- oferind o forta uimitoare si o parghie exceptionala, Boa Constrictor va prinde, rasuci, strange si desuruba orice forma sau material fara a zgaria



	L (mm)	L (inch)		
11021/21/ENB	6 - 100	1/4" - 4"	-	32.46



12002/07/ENB

Cheia multifunctionala cu cureaua 10-160 mm Boa Constrictor cu maner polipropilena cauciucat

- fara urme sau zgarieturi
- pentru utilizare in casa, garaj, atelier, fabrica, industrie si altele
- produs aprobat de NATO
- cheia multifunctionala Boa este utilizabila pentru cele mai vaste zone industriale din lume
- utilizare: aerospacial, NATO, optica, automobilistica, irigatii, agricultura, marina, hobby, constructii, industria petro-chimica etc.
- oferind o forta uimitoare si o parghie exceptionala, Boa Constrictor va prinde, rasuci, strange si desuruba orice forma sau material fara a zgaria



	L (mm)	L (inch)		
12002/07/ENB	10 - 160	3/8" - 6.3/4"	-	79.48



12001

Cheia multifunctionala cu cureaua 10-160 mm Boa Constrictor cu maner polipropilena

- fara urme sau zgarieturi
- pentru utilizare in casa, garaj, atelier, fabrica, industrie si altele
- produs aprobat de NATO
- cheia multifunctionala Boa este utilizabila pentru cele mai vaste zone industriale din lume
- utilizare: aerospacial, NATO, optica, automobilistica, irigatii, agricultura, marina, hobby, constructii, industria petro-chimica etc.
- oferind o forta uimitoare si o parghie exceptionala, Boa Constrictor va prinde, rasuci, strange si desuruba orice forma sau material fara a zgaria



	L (mm)	L (inch)		
12001	10 - 160	3/8" - 6.3/4"	-	61.97



14011/ENB

Set chei multifunctionale cu cureaua Boa Constrictor + Baby Boa

- fara urme sau zgarieturi
- pentru utilizare in casa, garaj, atelier, fabrica, industrie si altele
- produs aprobat de NATO
- cheia multifunctionala Boa este utilizabila pentru cele mai vaste zone industriale din lume
- utilizare: aerospacial, NATO, optica, automobilistica, irigatii, agricultura, marina, hobby, constructii, industria petro-chimica etc.
- oferind o forta uimitoare si o parghie exceptionala, Boa Constrictor va prinde, rasuci, strange si desuruba orice forma sau material fara a zgaria



14011/ENB	2	-	95.41
11022/21/ENB (6-100 mm), 12002/07/ENB (10-160 mm)			



13010/07

Cheia multifunctionala cu cureaua 10-285 mm Boa Constrictor cu maner din aluminiu cauciucat

- fara urme sau zgarieturi
- pentru utilizare in casa, garaj, atelier, fabrica, industrie si altele
- produs aprobat de NATO
- cheia multifunctionala Boa este utilizabila pentru cele mai vaste zone industriale din lume
- utilizare: aerospacial, NATO, optica, automobilistica, irigatii, agricultura, marina, hobby, constructii, industria petro-chimica etc.
- oferind o forta uimitoare si o parghie exceptionala, Boa Constrictor va prinde, rasuci, strange si desuruba orice forma sau material fara a zgaria



	L (mm)	L (inch)		
13010/07	10 - 285	3/8" - 10.3/4"	-	128.86



220/3

Chei pentru locas hexagonal

- material: crom vanadiu
- tratate
- acoperire prin nichelare
- conform cu standardul ISO 2936 (doar pentru dimensiunile in mm)

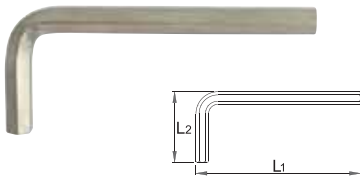

UNIOR Premium

Barcode	Hex	L1	L2	Weight	Price
607823	1.5	46.5	15.5	2.8	0.82
607824	2	52	18	1.72	0.82
607825	2.5	58.5	20.5	3	0.82
601036	3	66	23	5	1.48
601037	4	74	29	9.85	1.80
601038	5	85	33	18	3.11
601040	6	96	38	35	4.92
601041	7	102	41	47	7.21
601042	8	108	44	65	8.69
601044	10	122	50	108	15.08
601045	12	137	57	163	19.67
601046	14	154	70	258	32.62
601047	17	177	80	433	60.98
601048	19	199	89	603	92.95
616967	3/64"	41	13	5	0.82
616966	1/20"	41	13	5	0.66
611905	1/16"	47	16	5	15.08



Nu utilizati niciodata o prelungire sau alta forma de parghie pentru a creste efectul de parghie al vreunei chei.



Nu inclinati niciodata o cheie hexagonală. Piulita trebuie să fie așezată complet.



Nu folosiți niciodată un ciocan la cheile hexagonale



Nu expuneți niciodată nicio cheie la căldură excesivă, care poate modifica duritatea și structura metalică și poate deteriora unealta



Cheile nu trebuie polizate pentru a-și schimba forma.



Alegeți o cheie a cărei deschidere se potrivește exact.

Hex-L®

Cheie locas hexagonal, scurta

- unelte profesionale de inalta calitate industrială
- fabricate din oțel aliat Eklind®
- tratate termic pentru rezistența și ductilitate optime
- finisare cu Eklind® Black Finish pentru a rezista la rugina

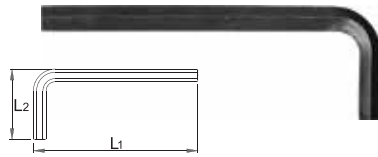

Eklind®

Barcode	Hex	L1	L2	Weight	Price
15500	0,7	31	6	1.2	1.31
15501	0,9	31	9	0.8	1.31
15502	1,3	41	13	2	1.15
15503	1,5	44	13	2	1.15
15504	2,0	49	15	3.6	1.15
15505	2,5	55	18	6.4	1.15
15506	3,0	62	19	10.4	1.15
15508	4,0	68	24	21.6	1.48
15510	5,0	78	27	39.2	2.30
15512	6,0	88	31	63	3.44
15514	7,0	93	35	90	5.41
15516	8,0	98	35	126	5.08
15518	9,0	103	39	168	7.87
15520	10,0	109	39	220	8.20
15524	12,0	122	44	370	15.90
15528	14,0	136	55	590	28.20
15534	17,0	156	61	980	37.87
15538	19,0	176	69	1360	58.20
15544	22,0	210	69	2060	83.77
15548	24,0	235	67	2740	126.72
15551	27,0	244	98	3850	330.82
15556	32,0	308	122	6480	397.05
15560	36,0	346	136	9550	496.39
15101	0.028"	31	6	0.4	1.31
15102	0.035"	31	9	1.6	1.31
15103	0.05"	42	13	2	1.15
15104	1/16"	44	14	3.2	1.15
15105	5/64"	48	15	3.6	1.15
15106	3/32"	51	17	5.6	1.15
15107	7/64"	54	18	8	1.31
15108	1/8"	57	19	11.2	1.31
15109	9/64"	60	20	14.8	1.31
15110	5/32"	64	21	19.6	1.31
15112	3/16"	70	24	31.2	1.80
15114	7/32"	76	26	47	2.79
15116	1/4"	83	28	67	3.44
15120	5/16"	95	32	120	5.41
15124	3/8"	108	35	194	7.87
15128	7/16"	121	38	310	16.23
15132	1/2"	133	41	430	18.69
15136	9/16"	146	44	600	27.87
15140	5/8"	159	48	824	36.23
15148	3/4"	184	54	1350	58.20
15156	7/8"	210	60	2050	86.89
15164	1"	235	67	2970	126.72
15166	1 1/8"	260	70	4350	390.33
15168	1 1/4"	308	122	6750	412.13
15172	1 1/2"	337	89	10600	515.08
15176	1 3/4"	387	102	14920	892.30
15180	2"	438	114	21700	1475.90

Hex-L® tamper resistant

Cheie locas hexagonal scurta cu gaura

- unelte profesionale de inalta calitate industrială
- fabricate din oțel aliat Eklind®
- tratate termic pentru rezistența și ductilitate optime
- finisare cu Eklind® Black Finish pentru a rezista la rugina

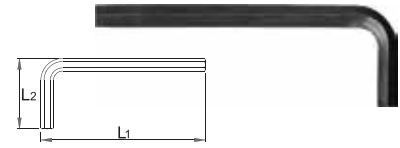

Eklind®

Barcode	Hex	L1	L2	Weight	Price
90206	3/32"	133	25	16	23.93
90208	1/8"	133	25	24	23.28
90210	5/32"	133	30	40	24.59
90212	3/16"	133	30	56	24.75
90214	7/32"	133	30	76	25.74
90216	1/4"	133	35	102	25.57
90220	5/16"	133	35	160	29.51
90224	3/8"	133	35	230	32.79

Ball-Hex™

Cheie locas hexagonal cu cap sferic

- unelte profesionale de inalta calitate industrială
- fabricate din oțel aliat Eklind®
- tratate termic pentru rezistența și ductilitate optime
- finisare cu Eklind® Black Finish pentru a rezista la rugina

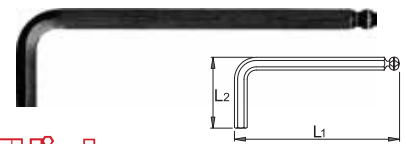
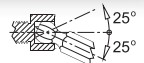

Eklind®

Barcode	Hex	L1	L2	Weight	Price
18602	1,3	72,1	13,5	60	NGU 5.95
18603	1,5	77,0	13,5	30	NGU 5.95
18604	2	81,0	15,5	60	NGU 5.95
18605	2,5	88,6	17,5	100	NGU 5.95
18606	3	98,6	19,1	150	NGU 6.13
18608	4	103,9	23,9	300	NGU 7.75
18609	4,5	110,2	25,4	200	8.66
18610	5	116,1	26,9	520	NGU 9.02
18612	6	137,9	31,0	890	NGU 11.36
18616	8	157,5	35,1	910	NGU 19.84
18620	10	167,4	39,1	1510	NGU 28.31
18624	12	209,0	43,9	2760	65.08
18628	14	232,4	54,6	4190	92.95
18634	17	246,1	61,5	1330	129.67
18638	19	275,6	68,6	1860	186.56



Hex-L®

Cheie pentru locas hexagonal lunga

- unelte profesionale de inalta calitate industriala
- fabricate din oel aliat Ekind®
- tratate termic pentru rezistenta si ductilitate optime
- finisare cu Ekind® Black Finish pentru a rezista la rugina

Ekind®

Barcode	Hex	L1	L2	Weight	Price
15600	0,7	66	6	0.4	2.79
15601	0,9	68	9	0.4	2.62
15602	1,3	72	13	2.4	0.98
15603	1,5	77	13	2.8	1.48
15604	2,0	81	15	5.6	1.48
15605	2,5	88	18	9.6	1.31
15606	3,0	99	19	15.2	1.31
15607	3,5	101	21	26	2.62
15608	4,0	104	24	30	2.62
15609	4,5	110	25	40	2.62
15610	5,0	116	27	53.2	2.62
15611	5,5	127	29	76	5.25
15612	6,0	138	31	90	5.25
15614	7,0	157	35	124	8.52
15616	8,0	157	35	184	8.52
15618	9,0	167	39	236	12.62
15620	10,0	167	39	306	13.11
15622	11,0	191	38	430	24.75
15624	12,0	209	44	560	23.93
15628	14,0	232	55	860	36.56
15634	17,0	246	61	1360	59.34
15638	19,0	276	69	1900	83.44
15644	22,0	356	69	3000	125.41
15648	24,0	362	67	3850	168.03
15651	27,0	413	98	5120	430.00
15656	32,0	503	122	8420	992.30
15660	36,0	514	136	13450	1256.72
15201	0.028"	66	6	0.4	2.95
15202	0.035"	68	9	0.8	2.62
15203	0.05"	72	13	2	1.31
15204	1/16"	76	14	3.2	1.31
15205	5/64"	81	15	5.6	1.48
15206	3/32"	86	17	9.6	1.48
15207	7/64"	90	18	12.4	1.80
15208	1/8"	95	19	16.8	2.13
15209	9/64"	100	20	22.4	2.13
15210	5/32"	105	21	28.8	2.30
15212	3/16"	114	24	46	2.62
15214	7/32"	124	26	68	3.93
15216	1/4"	133	28	97	5.41
15220	5/16"	152	32	174	8.20
15224	3/8"	171	35	280	12.79
15228	7/16"	191	38	440	24.43
15232	1/2"	210	41	620	27.87
15236	9/16"	229	44	860	37.87
15240	5/8"	248	48	1140	59.02
15248	3/4"	286	54	1870	86.56
15256	7/8"	324	60	2850	125.41
15264	1"	362	67	4110	168.03
15266	1 1/8"	400	70	7450	878.52
15268	1 1/4"	503	122	8420	892.30
15272	1 1/2"	514	89	14300	1578.52
15276	1 3/4"	591	102	22200	2182.62
15280	2"	670	114	30000	3571.80

220/3L

Cheie pentru locas hexagonal lunga

- material:crom vanadiu
- tratate
- acoperire prin nichelare
- conform cu standardul ISO 2936 (doar pentru dimensiunile in mm)

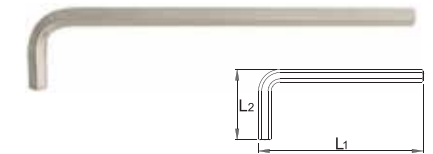

UNIOR® Premium

Barcode	Hex	L1	L2	Weight	Price
608510	1.5	91.5	15.5	1	3.61
608511	2	102	18	7	3.61
608512	2.5	114.5	20.5	10	4.26
608513	3	129	23	14	4.75
608514	4	144	29	22	6.89
608515	5	165	33	35	10.16
608516	6	186	38	55	10.16
608517	7	197	41	78	16.23
608518	8	208	44	105	16.39
608519	10	234	50	105	25.08
608520	12	262	57	105	39.34
608521	14	294	70	437	64.59
608522	17	337	80	753	109.34
608523	19	379	89	1026	174.10
616975	1/16"	92	16	6	3.28
616976	5/64"	102	18	7	3.28
616977	3/32"	114	20	10	4.10
616978	1/8"	129	23	14	4.43
616979	9/64"	140	26	22	5.25
616980	5/32"	144	29	22	6.23
616981	3/16"	165	33	35	7.54
616982	7/32"	176	36	55	8.36
616983	1/4"	186	38	55	9.34
616984	5/16"	208	44	105	15.08
616985	3/8"	234	50	105	23.77
616986	7/16"	261	53	105	35.41
616987	1/2"	293	63	105	46.39
616988	9/16"	294	69	437	59.67
616989	5/8"	336	76	753	106.89
616990	3/4"	379	89	1026	174.10



220/3S

Cheie pentru locas hexagonal scurta cu cap sferic

- material:crom vanadiu
- tratate
- acoperire prin nichelare

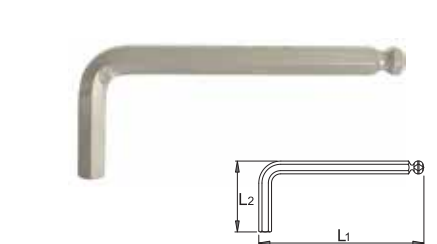

UNIOR® Premium

Barcode	Hex	L1	L2	Weight	Price
607826	1.5	46.5	15.5	5	3.93
607827	2	52	18	6	3.93
607828	2.5	58.5	20.5	7	4.26
607829	3	66	23	10	4.92
607830	4	74	29	15	7.38
607831	5	85	33	23	8.36
607832	6	96	38	35	12.79
607834	8	108	44	65	21.97
607835	10	122	50	108	38.52



220/3SL

Cheie pentru locas hexagonal lunga cu cap sferic

- material:crom vanadiu
- tratate
- acoperire prin nichelare

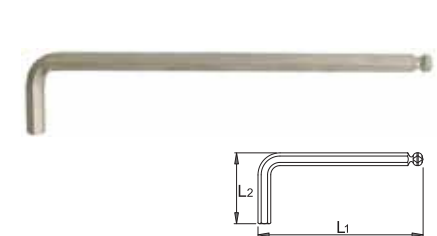

UNIOR® Premium

Barcode	Hex	L1	L2	Weight	Price
608524	1.5	91.5	15.5	6	4.26
608525	2	102	18	7	4.75
608526	2.5	114.5	20.5	10	5.41
608527	3	129	23	14	6.07
608528	4	144	29	22	8.85
608529	5	165	33	35	10.49
608530	6	186	38	55	15.74
608531	8	208	44	105	27.38
608532	10	234	50	105	49.18

220FH

Set chei locas hexagonal cu
maner tip briceag
2.5-10 mm / 7 piese



UNIOR

617146	2.5 - 10 / 7	300	144.92
└─ 220/3 (2.5, 3, 4, 5, 6, 8, 10)			

220/3MH

Set de chei locas hexagonal tip
briceag metalic



UNIOR

610986	2.5 - 10 / 7	349	94.10
└─ 220/3 (2.5, 3, 4, 5, 6, 8, 10)			

25161

Set chei locas hexagonal tip
briceag 3.0 - 10 mm / 6 piese



Eklind

25161	3.0 - 10 / 6	830	68.85
└─ (3,0; 4,0; 5,0; 6,0; 8,0; 10,0)			

**25171**

Set chei locas hexagonal tip
briceag 1.5-6.0 mm / 7 piese



Eklind

25171	1.5 - 6.0 / 7	288	39.84
└─ (1.5, 2.0, 2.5, 3.0, 4.0, 5.0, 6.0)			

25181

Set chei locas hexagonal tip
briceag



Eklind

25181	2.0 - 8.0 / 8	688	61.97
└─ (2,0; 2,5; 3,0; 4,0; 5,0; 6,0; 7,0; 8,0)			

220FH

Set chei locas hexagonal cu
maner tip briceag
3/32" - 3/8" / 7 piese



UNIOR

617149	3/32" - 3/8" / 7	300	144.92
└─ 220/3(3/32", 1/8", 5/32", 3/16", 1/4", 5/16", 3/8")			

25611

Set chei locas hexagonal tip
briceag 5/32"-3/8" / 6 piese



Eklind

25611	5/32"-3/8" / 6	833	68.85
└─ (5/32", 3/16", 7/32", 1/4", 5/16", 3/8")			

25911

Set chei locas hexagonal tip
briceag 5/64" - 1/4" / 9 piese



Eklind

25911	5/64" - 1/4" / 9	438	48.20
└─ (5/64", 3/32", 7/64", 1/8", 9/64", 5/32", 3/16", 7/32", 1/4")			

25912

Set chei locas hexagonal tip
briceag .050" - 3/16" / 9 piese



Eklind

25912	.050" - 3/16" / 9	250	41.31
└─ (.050", 1/16", 5/64", 3/32", 7/64", 1/8", 9/64", 5/32", 3/16")			

25919

Set chei locas hexagonal
cu cap sferic tip briceag
5/64" - 1/4" / 9 piese



Eklind

25919	5/64" - 1/4" / 9	825	75.90
└─ (5/64", 3/32", 7/64", 1/8", 9/64", 5/32", 3/16", 7/32", 1/4")			

25519

Set chei locas hexagonal cu cap sferic tip briceag 3/16" - 3/8" / 5 piese

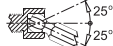

Eklind

25519	3/16" - 3/8" / 5	825	89.51
└─ (5/32", 3/16", 7/32", 1/4", 5/16", 3/8")			

220/3SFH

Set de chei locas hexagonal cu cap sferic cu maner tip briceag 2.5-10 mm / 7 piese



UNIOR

617147	2.5 - 10 / 7	298	191.80
└─ 220/3S (2.5, 3, 4, 5, 6, 8, 10)			

25169

Set de chei locas hexagonal cu cap sferic cu maner tip briceag 2.0-6.0 mm / 6 piese



Eklind

25169	2.0 - 6.0 / 6	288	61.97
└─ (2,0; 2,5; 3,0; 4,0; 5,0; 6,0)			



220/3PH

Set chei locas hexagonal in suport de plastic 1.5-12 mm / 10 piese



UNIOR Premium

617079	1.5 - 12 / 10	416	58.24
└─ 220/3 (1.5, 2, 2.5, 3, 4, 5, 6, 8, 10, 12)			

220/3-SET

NOU

Set chei locas hexagonal in 1.5 - 3 mm / 4 piese



UNIOR Premium

629440	1.5 - 3 / 4	18	4.10
└─ 220/3 (1.5, 2, 2.5, 3)			

220/3PB1

Set chei locas hexagonal in cutie de plastic 2-10 mm / 8 piese



UNIOR Premium

610914	2 - 10 / 8	310	66.39
└─ 220/3 (2, 2.5, 3, 4, 5, 6, 8, 10)			

10509

Set chei locas hexagonal in suport de plastic 1.5 - 10 mm / 9 piese



Eklind

10509	1.5 - 10 / 9	583	39.51
└─ (1,5; 2,0; 2,5; 3,0; 4,0; 5,0; 6,0; 8,0; 10,0)			

10107

Set chei locas hexagonal in suport de plastic 5/64" - 1/4" / 7 piese



Eklind

10107	5/64" - 1/4" / 7	242	18.03
└─ (5/64", 3/32", 1/8", 5/32", 3/16", 7/32", 1/4")			

10111

Set chei locas hexagonal in suport de plastic .050" - 1/4" / 11 piese



Eklind

10111	.050" - 1/4" / 11	283	29.34
└─ (.050", 1/16", 5/64", 3/32", 7/64", 1/8", 9/64", 5/32", 3/16", 7/32", 1/4")			



10112

Set chei locas hexagonal in suport de plastic .050" - 5/16" / 12 piese



Eklind

10112	.050" - 5/16" / 12	417	35.74
└─ (.050", 1/16", 5/64", 3/32", 7/64", 1/8", 9/64", 5/32", 3/16", 7/32", 1/4", 5/16")			

220/3PB1

Set chei locas hexagonal in cutie de plastic 5/64" - 3/8" / 8 piese



UNIOR Premium

612161	5/64" - 3/8" / 8	300	66.39
└─ (5/64", 3/32", 1/8", 5/32", 3/16", 1/4", 5/16", 3/8")			

220/3-SET

NOU

Set chei locas hexagonal 3/64" - 1/16" / 3 piese



UNIOR Premium

629441	3/64" - 1/16" / 3	9	2.79
└─ 220/3 (3/64", 1/20", 1/16")			

10113

Set chei locas hexagonal in suport de plastic .050" - 3/8" / 13 piese



Eklind

10113	.050" - 3/8" / 13	642	44.43
└─ (.050", 1/16", 5/64", 3/32", 7/64", 1/8", 9/64", 5/32", 3/16", 7/32", 1/4", 5/16", 3/8")			

10118

Set chei locas hexagonal scurte si lungi in suport plastic .050" - 5/16" / 18 piese



Eklind

10118	.050" - 5/16" / 18	675	42.62
└─ scurte: .050", 1/16", 5/64", 3/32", 7/64", 5/32", 3/16"; lungi: 1/16", 5/64", 3/32", 1/8", 9/64", 5/32", 3/16", 1/4", 5/16"			

220/3SPH

Set de chei locas hexagonal lungi in suport de plastic 1.5-10 mm / 9 piese

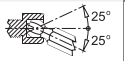

UNIOR

607853	1.5 - 10 / 9	252	116.07
└─ 220/3S (1.5, 2, 2.5, 3, 4, 5, 6, 8, 10)			

220/3S-SET

NOU

Set chei locas hexagonal cu cap sferic 1.5 - 3 mm / 4 piese

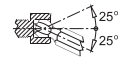

UNIOR Premium

629444	1.5 - 3 mm / 4	18	16.89
└─ 220/3 (1.5, 2, 2.5, 3)			

220/3PB1

Set chei locas hexagonal cu cap sferic in cutie de plastic 2-10 mm / 8 piese

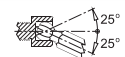

UNIOR Premium

610916	2 - 10 / 8	310	126.07
└─ 220/3 (2, 2.5, 3, 4, 5, 6, 8, 10)			

220/3LPH

Set de chei locas hexagonal lungi in suport de plastic 1.5-10 mm / 9 piese



UNIOR Premium

608533	1.5 - 10 / 9	416	96.23
220/3L (1.5, 2, 2.5, 3, 4, 5, 6, 8, 10)			

11609

Set de chei locas hexagonal, varianta lunga in suport de plastic 1.5-10 mm / 9 piese



Eklind

11609	1.5 - 10 / 9	798	57.54
220/3L (1.5, 2, 2.5, 3, 4, 5, 6, 8, 10)			

17007

Set chei locas hexagonal lungi cu cap sferic si profil special pentru suruburi deteriorate 1,5-10 mm / 9 piese in suport de plastic

- produs 2 in 1 - functioneaza ca o cheie locas hexagonal conventionala si ca extractor pentru suruburile si bolturi hexagonale deteriorate
- in primul rand nu va deteriora suruburile si bolturile hexagonale
- usor de folosit
- set de 9 chei cu clema pentru curea si suport pentru chei



boa

17007	1.5 - 10 / 9	865	215.41
(1.5, 2, 2.5, 3, 4, 5, 6, 8, 10)			

220/3LPH

Set de chei locas hexagonal, lungi in suport de plastic 1.5-12 mm / 10 piese



UNIOR Premium

617080	1.5 - 12 / 10	700	131.64
220/3L (1.5, 2, 2.5, 3, 4, 5, 6, 8, 10, 12)			

10609

Set de chei locas hexagonal lungi in suport de plastic 1.5-10 mm / 9 piese



Eklind

10609	1.5 - 10 / 9	815	54.43
(1.5, 2, 2.5, 3, 4, 5, 6, 8, 10)			



Produs 2 in 1 Functioneaza ca o cheie pentru locas hexagonal conventionala si ca un extractor

Industrial - Aerospacial - Automotive - Productie - Inगतii - Agricultura - Naval - Hobby - Constructii - Petrochimie - Gaze - Instalatii sanitare



220/3LPH

Set chei locas hexagonal lungi
in suport de plastic
1/16" - 3/8" / 9 piese



UNIOR Premium

617082	1/16" - 3/8" / 9	400	122.13
<p>220/3L (1/16", 5/64", 3/32", 1/8", 5/32", 3/16", 1/4", 5/16", 3/8")</p>			

220/3LPB2

Set chei locas hexagonal lungi
in cutie de plastic
2 - 10 mm / 8 piese



UNIOR Premium

610915	2 - 10 / 8	400	125.57
<p>220/3L (2, 2.5, 3, 4, 5, 6, 8, 10)</p>			

220/3L-SET**NOU**

Set chei locas hexagonal lungi
1.5 - 3 / 4 piese



UNIOR Premium

629442	1.5 - 3 / 4	27	16.39
<p>220/3L (1.5, 2, 2.5, 3)</p>			

220/3L-SET**NOU**

Set chei locas hexagonal lungi
1/16" - 1/8" / 4 piese



UNIOR Premium

629443	1/16" - 1/8" / 4	27	14.92
<p>220/3L (1/16", 5/64", 3/32", 1/8")</p>			

**10212**

Set chei locas hexagonal lungi
in suport de plastic .050" - 5/16"
/ 12 piese



Ekliind

10212	.050" - 5/16" / 12	617	46.07
<p>(.050", 1/16", 5/64", 3/32", 7/64", 1/8", 9/64", 5/32", 3/16", 7/32", 1/4", 5/16")</p>			

10211

Set chei locas hexagonal lungi
in suport de plastic .050"-1/4" /
11 piese



Ekliind

10211	.050" - 1/4" / 11	403	43.77
<p>(.050", 1/16", 5/64", 3/32", 7/64", 1/8", 9/64", 5/32", 3/16", 7/32", 1/4")</p>			



10207

Set chei locas hexagonal lungi in suport de plastic 5/64" - 1/4" / 7 piese



Eklind

10207	5/64" - 1/4" / 7	342	28.69
(5/64", 3/32", 1/8", 5/32", 3/16", 7/32", 1/4")			

10213

Set chei locas hexagonal lungi in suport de plastic .050" - 3/8" / 13 piese



Eklind

10213	.050" - 3/8" / 13	915	64.43
(.050", 1/16", 5/64", 3/32", 7/64", 1/8", 9/64", 5/32", 3/16", 7/32", 1/4", 5/16", 3/8")			

220/3SLPH

Set de chei locas hexagonal lungi cu cap sferic in suport de plastic 1.5-10 mm / 9 piese

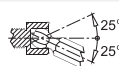

UNIOR Premium

608534	1.5 - 10 / 9	425	116.72
220/3SL (1.5, 2, 2.5, 3, 4, 5, 6, 8, 10)			

220/3SLPB2

Set de chei locas hexagonal lungi cu cap sferic in cutie de plastic 2 - 10 mm / 8 piese

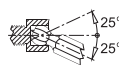

UNIOR Premium

610917	2 - 10 / 8	425	172.62
220/3SL (2, 2.5, 3, 4, 5, 6, 8, 10)			

13709

Set de chei locas hexagonal lungi cu cap sferic in suport de plastic 1.5-10 mm / 9 piese

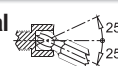

Eklind

13709	1.5 - 10 / 9	795	98.52
(1.5, 2, 2.5, 3, 4, 5, 6, 8, 10)			

17709

Set de chei locas hexagonal extralungi cu cap sferic in suport de plastic 1.5-10 mm / 9 piese

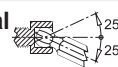

Eklind

17709	1.5 - 10 / 9	903	116.72
(1.5, 2, 2.5, 3, 4, 5, 6, 8, 10)			

13507

Set de chei locas hexagonal lungi cu cap sferic in suport de plastic 1.5-6 mm / 7 piese

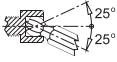

Eklind

13507	1.5 - 6 / 7	250	52.13
(1.5, 2, 2.5, 3, 4, 5, 6)			

29016

Set combo chei locas hexagonal 13609 si 25171 / 16 piese

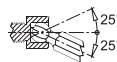

Eklind

29016	25171 + 13609 / 16	1080	125.41
25171: 1.5-6,0 / 7 piese (1,5; 2,0; 2,5; 3,0; 4,0; 5,0; 6,0)			
13609: 1.5-10,0 / 9 piese (1,5; 2,0; 2,5; 3,0; 4,0; 5,0; 6,0; 8,0; 10,0)			

13509

Set de chei locas hexagonal lungi cu cap sferic, varianta Stubby in suport de plastic 1.5-10 mm / 9 piese

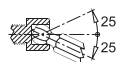

Eklind

13509	1.5 - 10 / 9	725	97.05
(1.5, 2, 2.5, 3, 4, 5, 6, 8, 10)			

17609

Set chei locas hexagonal lungi cu doua capete sferice in suport de plastic 1.5-10 mm / 9 piese

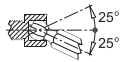

- bratul sferic scurt cu o sectiune mai mare pentru a rezista unui cuplu mai mare
- unghi de 100° pentru acces usor
- 20° interval de miscare
- acces in sigurata in zone greu accesibile
- in curs de brevetare



Gama completa de pozitii este de 20 grade

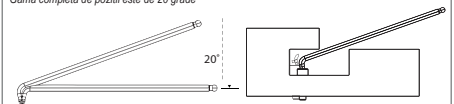

Eklind

17609	1.5 - 10 / 9	928	111.80
(1.5, 2, 2.5, 3, 4, 5, 6, 8, 10)			

13609

Set de chei locas hexagonal lungi cu cap sferic in suport de plastic 1.5-10 mm / 9 piese

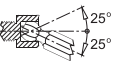

Eklind

13609	1.5 - 10 / 9	795	81.48
(1.5, 2, 2.5, 3, 4, 5, 6, 8, 10)			



220/3SL-SET

NOU

Set chei locas hexagonal cu cap sferic 1.5 - 3 mm / 4 piese

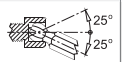

UNIOR Premium

629444	1.5 - 3 mm / 4	18	16.89
220/3SL(1.5, 2, 2.5, 3)			

13212

Set de chei locas hexagonal lungi cu cap sferic, in suport de plastic .050" - 5/16" / 12 piese

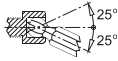

Eklind

13212 .050" - 5/16" / 12 620 70.49

(.050", 1/16", 5/64", 3/32", 7/64", 1/8", 9/64", 5/32", 3/16", 7/32", 1/4", 5/16")

13207

Set de chei locas hexagonal lungi cu cap sferic, in suport de plastic 5/64" - 1/4" / 7 piese

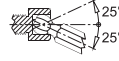

Eklind

13207 5/64" - 1/4" / 7 342 48.36

(5/64", 3/32", 1/8", 5/32", 3/16", 7/32", 1/4")

13297

Set de chei locas hexagonal lungi cu cap sferic, in suport de plastic 5/64" - 3/16" / 7 piese

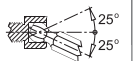

Eklind

13297 5/64" - 3/16" / 7 208 43.28

(5/64", 3/32", 7/64", 1/8", 9/64", 5/32", 3/16")

17213

Set chei locas hexagonal lungi cu doua capete sferice in suport de plastic .050" - 3/8" / 13 piese

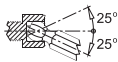

- bratul sferic scurt cu o sectiune mai mare pentru a rezista unui cuplu mai mare
- unghi de 100° pentru acces usor
- 20° interval de miscare
- acces in sigurata in zone greu accesibile
- in curs de brevetare



Gama completa de pozitii este de 20 grade

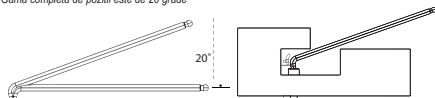

Eklind

17213 .050" - 3/8" / 13 1025 130.16

(.050", 1/16", 5/64", 3/32", 7/64", 1/8", 9/64", 5/32", 3/16", 7/32", 1/4", 5/16", 3/8")



AVERTIZARE!



Nu utilizați o țevă sau prelungire pe cheile hexagonale. A face acest lucru poate fi periculos.



Purtați întotdeauna ochelari de protecție.

13113

Set de chei locas hexagonal lungi cu cap sferic, varianta Stubby in suport de plastic .050" - 3/8" / 13 piese

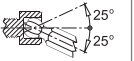

Eklind

13113 .050" - 3/8" / 13 817 114.59

(.050", 1/16", 5/64", 3/32", 7/64", 1/8", 9/64", 5/32", 3/16", 7/32", 1/4", 5/16", 3/8")

13111

NOU

Set de chei locas hexagonal lungi cu cap sferic, varianta Stubby in suport de plastic .050" - 1/4" / 11 piese

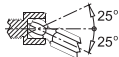

Eklind

13111 .050" - 1/4" / 11 366 84.57

(.050", 1/16", 5/64", 3/32", 7/64", 1/8", 9/64", 5/32", 3/16", 7/32", 1/4")

13122

Set combo de chei locas hexagonal lungi cu cap sferic, varianta Stubby in suport de plastic 13113+13509 / 22 piese

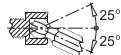

Eklind

13122 13113+13509 / 22 550 208.03

13113 .050"-3/8"/13 piese (.050", 1/16", 5/64", 3/32", 7/64", 1/8", 9/64", 5/32", 3/16", 7/32", 1/4", 5/16", 3/8")

13509 1.5-10 mm / 9 piese (1.5, 2, 2.5, 3, 4, 5, 6, 8, 10 mm)

220/3PB

Set de chei locas hexagonal in husa de plastic



UNIOR

601059 3 - 14 / 8 660 91.15

220/3 (3, 4, 5, 6, 8, 10, 12, 14)

601057 3 - 10 / 6 237 41.80

220/3 (3, 4, 5, 6, 8, 10)

601061 3 - 19 / 10 1715 252.62

220/3 (3, 4, 5, 6, 8, 10, 12, 14, 17, 19)

10592

Set de chei locas hexagonal in husa de plastic 0.7-10 mm / 12 piese



Eklind

10592 0,7 - 10 / 12 533 42.13

(0,7; 0,9; 1,3; 1,5; 2,0; 2,5; 3,0; 4,0; 5,0; 6,0; 8,0; 10,0)

69210

Set de chei locas hexagonal in husa de plastic 1.3-10 mm / 10 piese



Eklind

69210 1,3 - 10 / 10 530 34.10

(1,3; 1,5; 2,0; 2,5; 3,0; 4,0; 5,0; 6,0; 8,0; 10,0)

69511

Set de chei locas hexagonal in husa de plastic cu inel suport 1.5-10 mm / 10 piese



Eklind

69511 1,5 - 10 / 10 850 102.79

(1,5; 2,0; 2,5; 3,0; 4,0; 5,0; 6,0; 7,0; 8,0; 10,0)

69215

Set de chei locas hexagonal in husa de plastic .028" - 3/8" / 15 piese



Eklind

69215 .028" - 3/8" / 15 550 25.57

(.028", .035", .050", 1/16", 5/64", 3/32", 7/64", 1/8", 9/64", 5/32", 3/16", 7/32", 1/4", 5/16", 3/8")

69218

Set de chei locas hexagonal in husa de plastic .050" - 5/16" / 18 piese



Eklind

69218 .050" - 5/16" / 18 592 38.20

scurte: .050", 1/16", 5/64", 3/32", 7/64", 1/8", 9/64", 5/32", 7/32"

lungi: 1/16", 5/64", 3/32", 7/64", 5/32", 3/16", 1/4", 5/16"

69213

Set de chei locas hexagonal in husa de plastic cu inel suport .050" - 3/8" / 13 piese



Eklind

69213	.050" - 3/8" / 13	850	96.07
(.050", 1/16", 5/64", 3/32", 7/64", 1/8", 9/64", 5/32", 3/16", 7/32", 1/4", 5/16", 3/8")			

220/7TX

Chei locas cu profil TX cu gaura

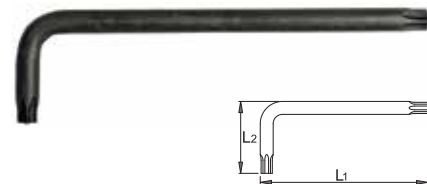
- material: crom vanadiu
- capul cheii este tratat in intregime
- acoperire prin brunare conform DIN 50938

UNIOR Premium

616296	TR 9	59	19	9	10	31.31
609173	TR 10	65	20	9	10	31.31
609174	TR 15	75.5	20.5	12	10	31.31
609175	TR 20	87	22	15	10	32.13
609176	TR 25	97.5	22.5	18	10	32.95
609177	TR 27	105.5	25.5	25	10	35.74
609178	TR 30	111	30	32	10	36.39
609179	TR 40	119	33	45	10	40.66



220/7TXN

Chei locas cu profil TX

- material: crom vanadiu
- capul cheii este tratat in intregime
- acoperire prin brunare conform DIN 50938

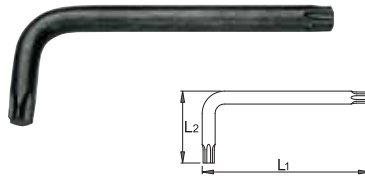

UNIOR Premium

616991	TX 6	44.5	18.5	7	10	21.15
616992	TX 7	50.5	18.5	7	10	21.15
616993	TX 8	51	19	8	10	21.15
616994	TX 9	51	19	8	10	18.85
616995	TX 10	54	20	8	10	19.34
616996	TX 15	57.5	21.5	10	10	19.34
616997	TX 20	61	23	13	10	19.51
616998	TX 25	64.5	24.5	15	10	20.00
616999	TX 27	69.5	26.5	21	10	21.48
617000	TX 30	76	30	25	10	21.48
617001	TX 40	83	33	35	10	24.26
617004	TX 55	120	47	126	10	40.49

Torx®

Chei locas cu profil TX, varianta scurta

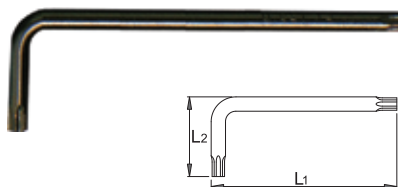
- instrumente profesionale de inalta calitate industrială
- fabricat din oțel aliat Eklind®
- tratate termic pentru rezistență și ductilitate optime
- finisat cu Eklind® Black Finish pentru a rezista la rugina
- cheile Torx® vor antrena elementele de fixare Torx®, Torx Plus® și stea cu nise și vor îndeplini toate standardele aplicabile stabilite de Acument Intellectual Properties, LLC.
- Torx® și Torx Plus® sunt mărci comerciale înregistrate ale Acument Intellectual Properties, LLC.



Eklind

15805	TX 5	39	12	6	22.95
15806	TX 6	40	12	10	21.80
15807	TX 7	42	13	8	20.00
15808	TX 8	44	14	4	20.00
15809	TX 9	48	15	10	20.00
15810	TX 10	51	17	8	7.05
15815	TX 15	54	18	12	7.38
15820	TX 20	57	19	19	7.70
15827	TX 27	64	22	27	8.85
15845	TX 45	83	29	106	13.77
15850	TX 50	95	32	124	15.74
15860	TX 60	133	41	430	36.56

Torx® L

Chei locas cu profil TX, varianta lunga

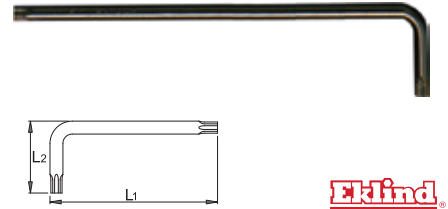
- instrumente profesionale de inalta calitate industrială
- fabricat din oțel aliat Eklind®
- tratate termic pentru rezistență și ductilitate optime
- finisat cu Eklind® Black Finish pentru a rezista la rugina
- cheile Torx® vor antrena elementele de fixare Torx®, Torx Plus® și stea cu nise și vor îndeplini toate standardele aplicabile stabilite de Acument Intellectual Properties, LLC.
- Torx® și Torx Plus® sunt mărci comerciale înregistrate ale Acument Intellectual Properties, LLC.

Eklind

15905	TX 5	69	12	8	24.10
15910	TX 10	86	17	13	7.38
15915	TX 15	91	18	18	7.87
15920	TX 20	95	19	28	8.20
15925	TX 25	100	20	31	9.02
15927	TX 27	105	22	44	9.84
15930	TX 30	114	24	52	10.82

Ball / Torx®

Chei locas cu profil TORX® și cap sferic

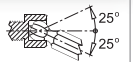

- instrumente profesionale de inalta calitate industrială
- fabricat din oțel aliat Eklind®
- tratate termic pentru rezistență și ductilitate optime
- finisat cu Eklind® Black Finish pentru a rezista la rugina
- cheile Torx® vor antrena elementele de fixare Torx®, Torx Plus® și stea cu nise și vor îndeplini toate standardele aplicabile stabilite de Acument Intellectual Properties, LLC.
- Torx® și Torx Plus® sunt mărci comerciale înregistrate ale Acument Intellectual Properties, LLC.

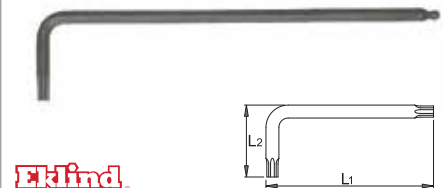
Eklind

15006	TX 6	70	12	4	25.08
15007	TX 7	72	13	6	23.77
15008	TX 8	76	14	8	23.77
15060	TX 60	210	41	476	46.89



Torx® TR

Chei locas cu profil TX cu gaura, varianta lunga

- instrumente profesionale de inalta calitate industriala
- fabricat din otel aliat Eklind®
- tratate termic pentru rezistenta si ductilitate optime
- finisat cu Eklind® Black Finish pentru a rezista la rugina
- cheile Torx® vor antrena elementele de fixare Torx®, Torx Plus® si stea cu nise si vor indeplini toate standardele aplicabile stabilite de Acument Intellectual Properties, LLC.
- Torx® si Torx Plus® sunt marci comerciale inregistrate ale Acument Intellectual Properties, LLC.

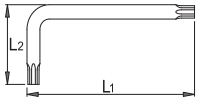

Eklind®

Barcode	Star	L1	L2	Qty	Price
15706	TR 6	70	12	8	30.82
15707	TR 7	72	13	10	29.02
15708	TR 8	76	14	8	29.02
15745	TR 45	133	29	150	24.59
15750	TR 50	152	32	176	26.39
15755	TR 55	171	35	312	39.51
15760	TR 60	210	41	490	52.30



220/7TXNFH

Set de chei cu profil TX cu maner tip briceag



UNIOR®

Barcode	Star	Qty	Price
617150	TX 9 - TX 40 / 8	225	199.02
220/7TXN (TX 9, TX 10, TX 15, TX 20, TX 25, TX 27, TX 30, TX 40)			

25570

Set de chei locas hexagonal cu profil TX tip briceag



Eklind®

Barcode	Star	Qty	Price
25570	TX 10 - TX 40 / 7	450	99.51
(TX 10, TX 15, TX 20, TX 25, TX 27, TX 30, TX 40)			

220/7TXPH

Set de chei cu profil TX Tamper cu gaura in suport de plastic



UNIOR®

Barcode	Star	Qty	Price
613089	TR 9 - TR 40 / 8	130	279.02
220/7TX (TR 9, TR 10, TR 15, TR 20, TR 25, TR 27, TR 30, TR 40)			

220/7TX-SET

NOU

Set de chei cu profil TX Tamper cu gaura

TR 9 - TR 15 / 3 piese



UNIOR® Premium

Barcode	Star	Qty	Price
629446	TR 9 - TR 15 / 3	3	39.02
220/3 (TR 9, TR 10, TR 15)			

220/7TXN-SET

NOU

Set de chei cu profil TX

TX 6 - TX 15 / 6 piese



UNIOR® Premium

Barcode	Star	Qty	Price
629447	TX 6 - TX 15 / 6	27	47.21
220/7TXN (TX 6, TX 7, TX 8, TX 9, TX 10, TX 15)			



10807

Set chei cu profil TORX in suport de plastic TX10-TX40 / 7 piese



Eklind

10807	TX 10 - TX 40 / 7	233	77.21
(TX 10, TX 15, TX 20, TX 25, TX 27, TX 30, TX 40)			

10707

Set chei cu profil TORX Tamper cu gaura in suport de plastic TX10-TX40 / 7 piese



Eklind

10707	TX 10 - TX 40 / 7	327	144.59
(TX 10, TX 15, TX 20, TX 25, TX 27, TX 30, TX 40)			

10814

Set chei cu profil TX in husa de plastic TX6-TX55 / 14 piese



Eklind

10814	TX 6 - TX 55 / 14	650	240.66
(T6; T7; T8; T9; T10; T15; T20; T25; T27; T30; T40; T45; T50; T55)			

10907

Set chei lungi cu profil TORX in suport de plastic TX10-TX40 / 7 piese



Eklind

10907	TX 10 - TX 40 / 7	325	98.36
(TX 10, TX 15, TX 20, TX 25, TX 27, TX 30, TX 40)			

11907

Set chei cu profil TORX cromate in suport de plastic TX10-TX40 / 7 piese



Eklind

11907	TX 10 - TX 40 / 7	327	86.89
(TX 10, TX 15, TX 20, TX 25, TX 27, TX 30, TX 40)			

10897

Set chei cu profil TX in husa de plastic TX6-TX55 / 14 piese



Eklind

10897	TX 6 - TX 55 / 14	90	103.11
(T6; T7; T8; T9; T10; T15; T20)			

10007

Set chei cu profil TX in suport de plastic TX10-TX40 / 7 piese

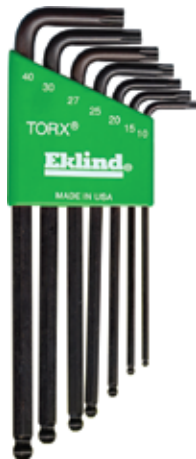
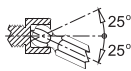

Eklind

10007	TX 10 - TX 40 / 7	325	107.38
(TX 10, TX 15, TX 20, TX 25, TX 27, TX 30, TX 40)			

220/7TXNPH

Set de chei cu profil TX in suport de plastic TX9-TX40 / 8 piese



UNIOR

617077	TX 9 - TX 40 / 8	130	171.48
220/7TN (TX 9, TX 10, TX 15, TX 20, TX 25, TX 27, TX 30, TX 40)			

10910

Set chei cu profil TX in husa de plastic TX10-TX55 / 10 piese



Eklind

10910	TX 10 - TX 55 / 10	1000	139.18
(T10, T15, T20, T25, T27, T30, T40, T45, T50, T55)			

10810

Set chei cu profil TX in husa de plastic TX10-TX55 / 7 piese



Eklind



10810 TX 10 - TX 55 / 7 687 130.66

(T10; T15; T20; T25; T27; T30; T40; T50; T55)

10714

Set chei cu profil TORX lungi in husa de plastic TX6-TX55 / 14 piese



Eklind



10714 TX 6 - TX 55 / 14 1000 391.85

(T6, T7, T8, T9, T10, T15, T20, T25, T27, T30, T40, T45, T50, T55)

25565

Set chei cu profil TORX Plus 27IP-50IP / 5 piese in briceag



Eklind



25565 27IP - 50IP / 5 800 101.48

(27IP, 30IP, 40IP, 45IP, 50IP)

10914

NOU

Set chei cu profil TORX lungi in husa de plastic TX6-TX55 / 14 piese



Eklind



10914 TX 6 - TX 55 / 14 1000 290.33

(T6, T7, T8, T9, T10, T15, T20, T25, T27, T30, T40, T45, T50, T55)

25575

Set chei cu profil TORX Plus 10IP-40IP / 7 piese in briceag



Eklind



25575 10IP - 40IP / 7 450 91.64

(10IP, 15IP, 20IP, 25IP, 27IP, 30IP, 40IP)

25585

Set chei cu profil TORX Plus 6IP-25IP / 8 piese in briceag



Eklind



25585 6IP - 25IP / 8 250 91.64

(6IP, 7IP, 8IP, 9IP, 10IP, 15IP, 20IP, 25IP)

193HX

Chei hexagonale cu maner in T

- material:tija-crom vanadiu tratata complet
- maner-polipropilena
- lama cromata, varful brunat

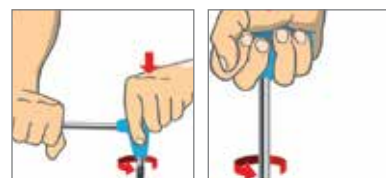
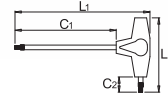
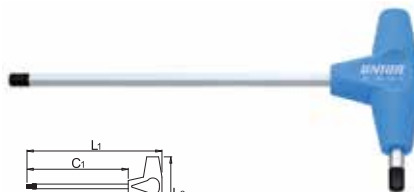

UNIOR

Barcode	Hex	L1	C1	C2	L2	Weight	Price
623238	2	155	125	15	61	12	22.95
607161	2.5	155	125	15	61	13	22.95
607162	3	155	125	15	61	16	23.44
607163	3.5	155	125	15	61	20	23.93
607164	4	155	125	15	61	24	30.00
607165	4.5	188	150	20	88	57	30.33
607166	5	188	150	20	88	56	33.61
607167	6	188	150	20	88	74	36.56
607168	7	223	175	25	113	128	49.34
607169	8	223	175	25	113	155	51.80
607170	10	248	200	25	113	233	67.54

Power-T™ Hex 6"

Chei cu maner in T si profil hexagonal, varianta scurta

- instrumente profesionale de inalta calitate industriala
- fabricat din otel aliat Eklind®.
- tratat termic pentru rezistenta si ductilitate optime.
- finisat cu Eklind® Black Finish pentru a rezista la rugina
- cheile hexagonale Eklind® cu maner in T ofera o raza suplimentara si o parghie suplimentara
- cheile hexagonale cu maner in T Eklind® Power-T™ au un maner moale si texturat pentru un plus de confort, rezistenta la alunecare si siguranta

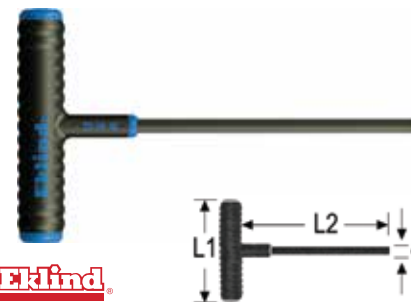

Eklind

Barcode	Hex	L1	L2	Weight	Price
64620	2,0	76	152	113	15.57
64625	2,5	76	152	113	15.90
64630	3,0	76	152	125	17.70
64640	4,0	76	152	138	20.33
64650	5,0	102	152	310	21.97
64660	6,0	102	152	345	27.87
64670	7,0	127	152	625	45.57
64680	8,0	127	152	655	43.93
64685	9,0	127	152	700	50.49
64690	10,0	127	152	740	50.49

Power-T™ Hex 6"

Cheie cu maner in T si profil hexagonal, varianta scurta

- instrumente profesionale de inalta calitate industriala
- fabricat din otel aliat Eklind®.
- tratat termic pentru rezistenta si ductilitate optime.
- finisat cu Eklind® Black Finish pentru a rezista la rugina
- cheile hexagonale Eklind® cu maner in T ofera o raza suplimentara si o parghie suplimentara
- cheile hexagonale cu maner in T Eklind® Power-T™ au un maner moale si texturat pentru un plus de confort, rezistenta la alunecare si siguranta

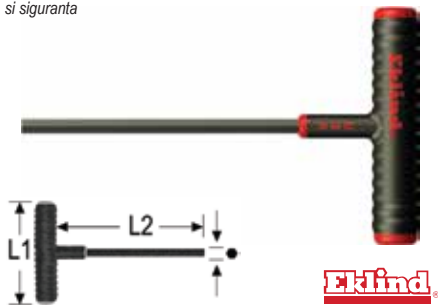

Barcode	Hex	L1	L2	Weight	Price
61605	5/64"	76	152	105	16.07
61606	3/32"	76	152	110	15.90
61607	7/64"	76	152	115	16.89
61608	1/8"	76	152	120	17.87
61609	9/64"	76	152	125	20.00
61610	5/32"	76	152	130	20.33
61612	3/16"	102	152	310	22.95
61614	7/32"	102	152	330	23.93
61616	1/4"	102	152	355	32.30
61620	5/16"	127	152	655	43.61
61624	3/8"	127	152	710	48.20

Power-T™ Hex 9"

Cheie cu maner in T si profil hexagonal, varianta lunga

- instrumente profesionale de inalta calitate industriala
- fabricat din otel aliat Eklind®.
- tratat termic pentru rezistenta si ductilitate optime.
- finisat cu Eklind® Black Finish pentru a rezista la rugina
- cheile hexagonale Eklind® cu maner in T ofera o raza suplimentara si o parghie suplimentara
- cheile hexagonale cu maner in T Eklind® Power-T™ au un maner moale si texturat pentru un plus de confort, rezistenta la alunecare si siguranta

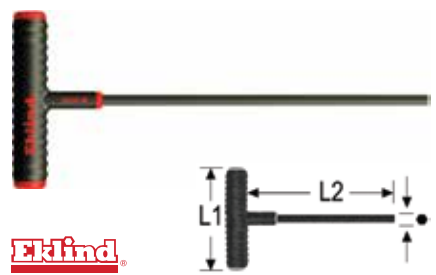

Barcode	Hex	L1	L2	Weight	Price
61905	5/64"	76	229	110	17.87
61906	3/32"	76	229	115	17.70
61907	7/64"	76	229	125	18.52
61908	1/8"	76	229	130	20.00
61909	9/64"	76	229	140	20.82
61910	5/32"	76	229	150	21.64
61912	3/16"	102	229	330	23.28
61914	7/32"	102	229	360	27.21
61916	1/4"	102	229	400	34.10
61920	5/16"	127	229	725	48.20
61924	3/8"	127	229	815	53.28

Power-T™ Ball-Hex 9"

Cheie cu maner in T si profil hexagonal cu cap sferic, varianta lunga

- instrumente profesionale de inalta calitate industriala
- fabricat din otel aliat Eklind®.
- tratat termic pentru rezistenta si ductilitate optime.
- finisat cu Eklind® Black Finish pentru a rezista la rugina
- cheile hexagonale Eklind® cu maner in T ofera o raza suplimentara si o parghie suplimentara
- cheile hexagonale cu maner in T Eklind® Power-T™ au un maner moale si texturat pentru un plus de confort, rezistenta la alunecare si siguranta

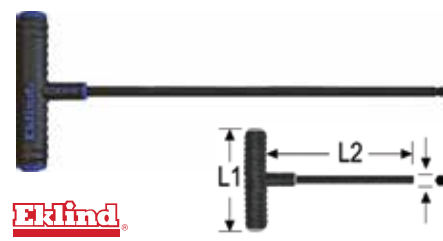

Barcode	Hex	L1	L2	Weight	Price
64820	2,0	51	229	0.110	20.66
64825	2,5	51	229	0.120	21.64
64830	3,0	76	229	0.125	20.66
64840	4,0	76	229	0.150	23.44
64850	5,0	102	229	0.340	25.57
64860	6,0	102	229	0.385	34.10
64870	7,0	127	229	0.700	54.43
64880	8,0	127	229	0.725	54.43
64885	9,0	127	229	0.800	59.67
64890	10,0	127	229	0.845	59.67

Power-T™ Hex 9"

Cheie cu maner in T si profil hexagonal, varianta lunga

- cheile Eklind Power-T™ sunt fabricate din Eklind Alloy Steel™ de cea mai inalta calitate
- construite cu un miez din otel solid pentru rezistenta maxima
- tratate termic pentru rezistenta maxima si finisate pentru a rezista la rugina
- manere cu aderenza dubla ofera confort sporit si rezistenta la alunecare pentru siguranta

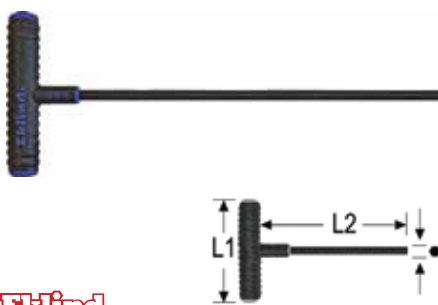

Barcode	Hex	L1	L2	Weight	Price
64920	2,0	76	229	110	17.21
64925	2,5	76	229	120	17.21
64930	3,0	76	229	125	19.51
64940	4,0	76	229	150	21.64
64950	5,0	102	229	340	23.93
64960	6,0	102	229	385	30.98
64970	7,0	127	229	665	51.31
64980	8,0	127	229	725	49.67
64985	9,0	127	229	895	54.26
64990	10,0	127	229	855	54.26

193HXS

Cheie hexagonale cu cap sferic si cu maner

- material:tija-crom vanadiu tratata complet
- maner-polipropilena
- lama cromata, varful brunat



Barcode	Hex	L1	C1	C2	L2	Weight	Price
608276	2.5	155	125	15	61	13	23.61
608277	3	155	125	15	61	16	24.59
608278	4	155	125	15	61	25	30.82
608279	5	188	150	20	88	56	34.75
608280	6	188	150	20	88	72	38.20
608281	8	223	175	25	113	153	54.10
608282	10	248	200	25	113	234	70.98

Power-T™ Ball-Hex 9"

Cheie cu maner in T si profil hexagonal cu cap sferic, varianta lunga

- instrumente profesionale de inalta calitate industriala
- fabricat din otel aliat Eklind®.
- tratat termic pentru rezistenta si ductilitate optime.
- finisat cu Eklind® Black Finish pentru a rezista la rugina
- cheile hexagonale Eklind® cu maner in T ofera o raza suplimentara si o parghie suplimentara
- cheile hexagonale cu maner in T Eklind® Power-T™ au un maner moale si texturat pentru un plus de confort, rezistenta la alunecare si siguranta

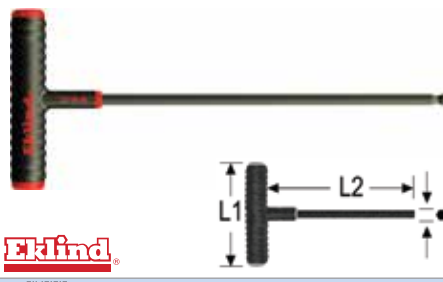

Barcode	Hex	L1	L2	Weight	Price
61805	5/64"	51	229	0.110	20.66
61806	3/32"	51	229	0.115	20.66
61807	7/64"	51	229	0.125	20.66
61808	1/8"	76	229	0.130	21.64
61809	9/64"	76	229	0.140	21.64
61810	5/32"	76	229	0.150	24.43
61812	3/16"	102	229	0.335	24.59
61814	7/32"	102	229	0.360	34.26
61816	1/4"	102	229	0.395	36.23
61820	5/16"	127	229	0.720	53.77
61824	3/8"	127	229	0.815	59.18

193HXC

Set de surubelnite cu cap hexagonal in cutie de carton



UNIOR

608879	2.5 - 10 / 10	884	369.34
↪ 193HX (2.5, 3, 3.5, 4, 4.5, 5, 6, 7, 8, 10)			

193HXS

Set de surubelnite cu cap hexagonal in cutie de carton



UNIOR

607890	2.5 - 10 / 7	743	265.74
↪ 193HX (2.5, 3, 4, 5, 6, 8, 10)			

193HXSCS

Set de surubelnite cu cap hexagonal sferic in cutie de carton

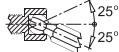

UNIOR

609337	2.5 - 10 / 7	739	277.05
↪ 193HXS (2.5, 3, 4, 5, 6, 8, 10)			



60611

Set de surubelnite cu cap hexagonal varianta 6" in husa plastic

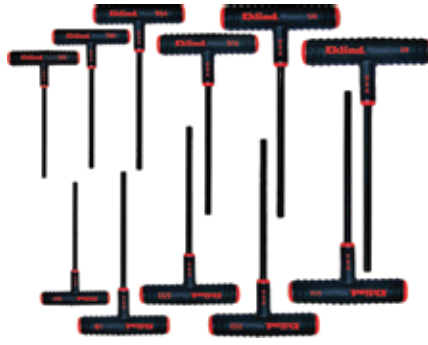

Eklind

60611	5/64" - 3/8" / 11	3300	308.85
↪ (5/64", 3/32", 7/64", 1/8", 9/64", 5/32", 3/16", 7/32", 1/4", 5/16", 3/8")			

64806

Set de surubelnite cu cap hexagonal sferic varianta 9" in husa plastic

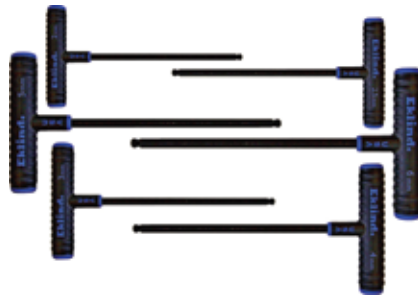
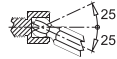

Eklind

64806	2.0 - 6.0 / 6	1600	198.52
↪ (2, 2.5, 3, 4, 5, 6)			

64808

Set de surubelnite cu cap hexagonal sferic varianta 9" in husa plastic

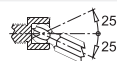

Eklind

64808	2.0 - 10.0 / 8	3000	308.85
↪ (2, 2.5, 3, 4, 5, 6, 8, 10)			

193TX

Chei cu maner in T cu profil TX

- material: tija-crom vanadiu tratata complet
- maner-polipropilena
- lama cromata, varful brunat



UNIOR

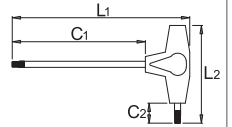

Barcode	Star	L1	C1	C2	L2	Weight	Price
607171	TX 6	155	125	15	61	15	41.15
607172	TX 7	155	125	15	61	15	41.15
607173	TX 8	155	125	15	61	15	41.31
607174	TX 9	155	125	15	61	15	41.31
607175	TX 10	155	125	15	61	15	41.64
607176	TX 15	155	125	15	61	19	47.54
607177	TX 20	155	125	15	61	22	51.80
607178	TX 25	188	150	20	88	46	54.43
607179	TX 27	188	150	20	88	58	58.03
607180	TX 30	188	150	20	88	67	66.89
607181	TX 40	223	175	25	113	118	69.34
607182	TX 45	223	175	25	113	142	82.30

Power-T™ Torx®

Chei cu maner in T si profil TORX®

- cheile Eklind Power-T™ sunt fabricate din Eklind Alloy Steel™ de cea mai inalta calitate
- construite cu un miez din otel solid pentru rezistenta maxima
- tratate termic pentru rezistenta maxima si finisate pentru a rezista la rugina
- manere cu aderența dubla ofera confort sport si rezistenta la alunecare pentru siguranta



Eklind

Barcode	Star	L1	L2	Weight	Price
68606	T6	76	152	46	27.54
68607	T7	76	152	46	27.54
68608	T8	76	152	46	27.54
68609	T9	76	152	46	27.54
68610	T10	76	152	46	27.54
68615	T15	76	152	48	26.56
68620	T20	76	152	50	27.54
68625	T25	76	152	52	27.54
68627	T27	102	152	122	34.43
68630	T30	102	152	130	38.03
68640	T40	102	152	142	48.20
68645	T45	127	152	131	61.97
68650	T50	127	152	143	65.25

193TXCB

Set de surubelnite profil TX cu maner in T in cutie de carton



UNIOR

608880 TX 6 - TX 45 / 10 631 554.75

193TX (TX 6, TX 8, TX 10, TX 15, TX 20, TX 25, TX 27, TX 30, TX 40, TX 45)

193TXCS

Set de surubelnite profil TX cu maner in T in cutie de carton



UNIOR

607888 TX 10 - TX 45 / 7 605 414.26

193TX (TX 10, TX 15, TX 20, TX 25, TX 30, TX 40, TX 45)



Power-T™ Torx® Plus 6"

Cheie cu maner in T si profil TORX® Plus 6"

- cheile Eklind Power-T™ sunt fabricate din Eklind Alloy Steel™ de cea mai inalta calitate
- construite cu un miez din otel solid pentru rezistenta maxima
- tratate termic pentru rezistenta maxima si finisate pentru a rezista la rugina
- manere cu aderența dubla ofera confort sporit si rezistenta la alunecare pentru siguranta

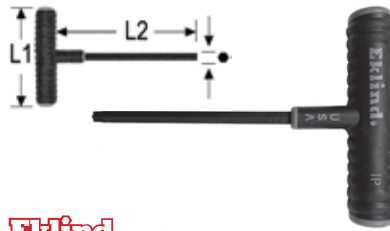

Eklind

Articol	Tip	L1	L2	Pondere	Pret
68706	6IP	76	152	115	28.69
68707	7IP	76	152	115	28.69
68708	8IP	76	152	115	28.69
68709	9IP	76	152	115	28.69
68710	10IP	76	152	115	28.69
68715	15IP	76	152	120	28.69
68720	20IP	76	152	125	28.69
68725	25IP	76	152	130	28.69
68727	27IP	102	152	305	36.07
68730	30IP	102	152	325	39.34
68740	40IP	102	152	355	50.00
68745	45IP	127	152	655	64.59
68750	50IP	127	152	715	67.87

Power-T™ Torx® Plus 9"

Cheie cu maner in T si profil TORX® Plus 9"

- cheile Eklind Power-T™ sunt fabricate din Eklind Alloy Steel™ de cea mai inalta calitate
- construite cu un miez din otel solid pentru rezistenta maxima
- tratate termic pentru rezistenta maxima si finisate pentru a rezista la rugina
- manere cu aderența dubla ofera confort sporit si rezistenta la alunecare pentru siguranta

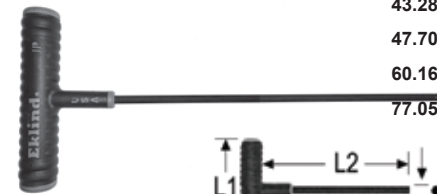

Eklind

Articol	Tip	L1	L2	Pondere	Pret
69906	6IP	76	229	140	28.83
69907	7IP	76	229	140	28.83
69908	8IP	76	229	140	28.83
69909	9IP	76	229	140	28.83
69910	10IP	76	229	140	28.83
69915	15IP	76	229	145	28.83
69920	20IP	76	229	150	28.83
69925	25IP	76	229	155	28.83
69927	27IP	102	229	330	36.22
69930	30IP	102	229	350	39.93
69940	40IP	102	229	380	50.42
69945	45IP	127	229	705	64.61
69950	50IP	127	229	765	68.31

68700

Set de surubelnite cu profil TORX® Plus 6" in husa plastic 6IP - 50IP / 11 piese

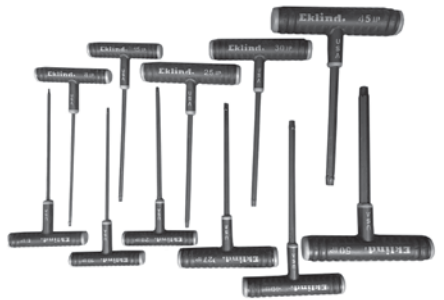

Eklind

68700 6IP - 50IP / 11 3340 431.48

(6IP, 8IP, 10IP, 15IP, 20IP, 25IP, 27IP, 30IP, 40P, 45IP, 50IP)

68701

Set de surubelnite cu profil TORX® Plus 6" in husa plastic 6IP - 20IP / 7 piese



Eklind

68701 6IP - 20IP / 7 1000 266.72

(6IP, 7IP, 8IP, 9IP, 10IP, 15IP, 20IP)

68702

Set de surubelnite cu profil TORX® Plus 6" in husa plastic 10IP - 40IP / 7 piese



Eklind

68702 10IP - 40IP / 7 2000 266.72

(10IP, 15IP, 20IP, 25IP, 27IP, 30IP, 40P, 45IP)

69900

Set de surubelnite cu profil TORX® Plus 9" in husa plastic 6IP - 50IP / 11 piese



Eklind

69900 6IP - 50IP / 11 4400 513.77

(6IP, 8IP, 10IP, 15IP, 20IP, 25IP, 27IP, 30IP, 40P, 45IP, 50IP)

69901

Set de surubelnite cu profil TORX® Plus 9" in husa plastic 6IP - 20IP / 7 piese



Eklind

69901 6IP - 20IP / 7 1000 320.00

(6IP, 7IP, 8IP, 9IP, 10IP, 15IP, 20IP)

69902

Set de surubelnite cu profil TORX® Plus 9" in husa plastic 10IP - 40IP / 7 piese



Eklind

69902 10IP - 40IP / 7 2000 320.00

(10IP, 15IP, 20IP, 25IP, 27IP, 30IP, 40P, 45IP)

DIAMETRU DE FILETARE

	Suruburi metrice
	Suruburi metrice fara cap
	Suruburi auto-filetante
	Suruburi pentru lemn

CHEI PENTRU LOCAS HEXAGONAL

Dimensiune	Cuplu minim	Suruburi metric						
		Capac		Cap frezat	Suruburi fara cap			
	ISO 4762					ISO 4026 4029	ISO 4027	ISO 4028
	DIN	DIN	DIN	DIN	DIN	DIN	DIN	DIN
	911	912	6912	7984	7991	913	914	915
	Nm					916		
0,7	0,08					1,4	1,4	1,4
						1,6	1,6	1,6
						1,8	1,8	1,8
0,9	0,18					2	2	2
1,3	0,53	1,4			2,5	2,5	2,5	2,5
1,5	0,82	1, 6-2				3	3	3
2	1,9	2,5		3	3	4	4	4
2,5	3,8	3		4	4	5	5	5
3	6,6	4	4	5	5	6	6	6
4	16	5	5	6	6	8	8	8
5	30	6	6	8	8	10	10	10
6	52	8	8		10	12	12	12
						14	14	14
7	78			10				
8	120	10	10	12	12	16	16	16
10	220	12	12	14	14	18	18	18
						20	20	20
12	370	14	14	1 6	16	22	22	22
				18	18	24	24	24
14	590	1 6	16	20	20			
		18	18	22	22			
17		20	20	24	24			
		22	22					
19		24	24					
		27	27					
22	1000	30	30					
24		33	33					
27		36	36					
32		42						

